

# MICROTECH<sup>®</sup> UNIT CONTROLLER

FOR REBEL<sup>®</sup> COMMERCIAL PACKAGED ROOFTOP SYSTEMS



- MODEL DPS
- R-32 REFRIGERANT

# Table of Contents

<b>Introduction</b> .....	<b>4</b>	<b>Cooling</b> .....	<b>50</b>
MicroTech Fundamentals .....	4	Cooling Menus .....	52
<b>Keypad and Display</b> .....	<b>6</b>	<b>Dehumidification</b> .....	<b>56</b>
Main Menu .....	6	Dehumidification Menus .....	60
<b>Field Wired Inputs</b> .....	<b>12</b>	<b>Heating</b> .....	<b>63</b>
MicroTech Field Wiring .....	14	Heating Menus .....	66
<b>Temporary Operations</b> .....	<b>17</b>	<b>Outside Air Damper</b> .....	<b>71</b>
Manual Unit Operation .....	17	OA Damper Menus .....	75
Temporary Operation for Heating and Cooling .....	20	<b>Economizer Control</b> .....	<b>77</b>
<b>Unit Set-Up</b> .....	<b>21</b>	Economizer Menus .....	81
Unit Set-Up Menu .....	21	<b>Energy Recovery</b> .....	<b>84</b>
Enable the Unit .....	22	Energy Recovery Wheel Commissioning .....	87
<b>Occupancy</b> .....	<b>23</b>	<b>Other Configurations</b> .....	<b>88</b>
Occupancy Menu .....	25	Timer Settings .....	88
<b>Scheduling</b> .....	<b>26</b>	Humidity Sensor Set-Up .....	89
Date/Time/Schedules Menu .....	27	Remote Sensor Set-Up .....	90
Optimal Start (Morning Warm-Up/Cool Down) .....	28	Set-Up and Commissioning Sensors .....	90
Optimal Start Menu .....	29	Configurable I/O .....	95
Purge Menu .....	29	Trending Set-Up .....	96
<b>Quick Menu</b> .....	<b>30</b>	Trending Set-Up Menu .....	101
<b>Unit State</b> .....	<b>33</b>	BMS Communications .....	102
Unit Status/Settings .....	36	LON Set-Up .....	102
Control Type .....	39	BACnet MSTP Set-Up .....	103
Heating/Cooling Changeover .....	39	BACnet IP Set-Up .....	104
Heat/Cool Changeover Menu .....	41	Network Unit Set-Up .....	105
Supply Air Fan .....	42	Network Input Status .....	107
Supply Fan Menu .....	43	Power Monitor .....	109
Supply Fan Set-Up Menu .....	43	<b>Unit Maintenance and Service Menus</b> .....	<b>111</b>
Exhaust Fan .....	46	Unit Maintenance .....	111
Exhaust Fan Menus .....	48	Operating Hours Menu .....	111
		Air Filters .....	112

©2024 Daikin Applied, Minneapolis, MN. All rights reserved throughout the world. This document contains the most current product information as of this printing. Daikin Applied Americas Inc. has the right to change the information, design, and construction of the product represented within the document without prior notice. For the most up-to-date product information, please go to [www.DaikinApplied.com](http://www.DaikinApplied.com).

™@ MicroTech, SiteLine, and Daikin Applied are trademarks or registered trademarks of Daikin Applied Americas Inc. The following are trademarks or registered trademarks of their respective companies: BACnet from American Society of Heating, Refrigerating and Air-Conditioning Engineers, Inc.; Echelon, LonWorks, LonMark, and LonTalk from Echelon Corporation; Modbus from Schneider Electric; and Windows from Microsoft Corporation.

Operating Hours . . . . .	113	OAF Flow Control . . . . .	148
Temperatures . . . . .	114	SAF Flow Control . . . . .	148
<b>Alarms and Events . . . . .</b>	<b>115</b>	SAF BSP Control . . . . .	149
Viewing Alarms . . . . .	115	Exhaust Fans . . . . .	149
Alarm and Event Descriptions . . . . .	116	Heating and Cooling Change Over . . . . .	152
Problems . . . . .	119	HtgClg ChangOvr Set-up . . . . .	153
Faults . . . . .	122	Cooling Set-Up . . . . .	155
<b>Viewing Events . . . . .</b>	<b>123</b>	OAF Set-Up . . . . .	156
Event Log . . . . .	123	Economizer and Outside Air Damper . . . . .	157
Standby Events . . . . .	124	Econo Set-Up . . . . .	157
Event Troubleshooting . . . . .	124	OA Damper Set-Up . . . . .	158
Alarm/Event Configurations . . . . .	125	Heating . . . . .	161
Data Snapshots . . . . .	125	Reheat . . . . .	162
<b>MicroTech Inputs/Outputs . . . . .</b>	<b>126</b>	Reheat Set-Up . . . . .	162
Main Control Board . . . . .	126	Energy Rec Set-Up . . . . .	163
Expansion Module A I/O (POL965 or POL96E/U) . . . . .	128	Power Monitor . . . . .	164
Expansion Module B I/O (POL965) . . . . .	129	A2L Sensors . . . . .	165
Expansion Module E I/O (POL96E/U or POL98U) . . . . .	130	Sensor Offsets . . . . .	165
Expansion Module H I/O (POL965) . . . . .	132	<b>A2L Detection and Mitigation . . . . .</b>	<b>167</b>
Expansion Model J I/O (POL965) . . . . .	133	A2L Leak Detection System . . . . .	167
Universal I/O, Digital Input Status, Digital Output Status 134		A2L Leak Mitigation . . . . .	167
Network Input Status . . . . .	134	A2L Leak Detection Sensor and Board Service . . . . .	169
Modbus Status . . . . .	136	A2L Leak Detection Sensor and Board Troubleshooting and Diagnostics . . . . .	169
<b>Advanced Operation . . . . .</b>	<b>138</b>	<b>Appendix . . . . .</b>	<b>173</b>
Unit Configuration . . . . .	138	Gas Furnace Controller Diagnostic Codes . . . . .	173
Unit Set-Up . . . . .	144	Modulating Gas Heat Controller (VB1285) Modbus Addresses . . . . .	173
Advanced Timers . . . . .	144	ModBus . . . . .	176
Supply Fans . . . . .	146	Data Snapshot Tables . . . . .	176
SAF DSP Control . . . . .	147	Limited Warranty . . . . .	179
1 Zone VAV Control . . . . .	147		

# Introduction

This manual provides operating information and controller operation sequences, maintenance, and start-up procedures for packaged rooftop systems.



## WARNING

Only qualified personnel should install, operate and service the equipment and that improper adjustment of settings and operation by an unqualified person could result in property damage, injury, or death.

## MicroTech Fundamentals

### Getting Started

This manual contains information designed to assist the field technician with unit setup. The technician will need to be familiar with the following topics, at a minimum, to successfully set up unit operation:

- Keypad navigation/editing/passwords
- Control Mode
- Occ Mode (Occupancy)
- DSP Set point (Duct Static Pressure)
- BSP Set point (Building Static Pressure)
- Heat/Cool Changeover
- DAT Clg Set point (Discharge Air Temperature)
- DAT Htg Set point (Discharge Air Temperature)
- Clg Enable (OAT/EWT lockout)
- Htg Enable (OAT lockout)
- Econo Enable (Changeover temp/Enthalpy switch)
- Ventilation Limit/OA damper

The keypad/display consists of a 5-line by 22 character display, three keys and a “push and roll” navigation wheel. There is an **Alarm Button**, **Menu (Home) Button**, and a **Back Button**. The wheel is used to navigate between lines on a screen (page) and to increase and decrease changeable values when editing. Pushing the wheel acts as an **Enter Button**.

**Figure 1: Keypad Controls**



The first line on each page includes the page title and the line number to which the cursor is currently “pointing.” The line numbers are X/Y to indicate line number X of a total of Y lines for that page. The left most position of the title line includes an “up” arrow to indicate there are pages “above” the currently displayed items, a “down” arrow to indicate there are pages “below” the currently displayed items, or an “up/down” arrow to indicate there are pages “above and below” the currently displayed page.

Each line on a page can contain status only information or include changeable data fields. When a line contains status only information and the cursor is on that line, all but the value field of that line is highlighted - meaning the text is white with a black box around it. When the line contains a changeable value and the cursor is at that line, the entire line is highlighted. Each line on a page may also be defined as a “jump” line, meaning pushing the navigation wheel will cause a “jump” to a new page. An arrow is displayed to the far right of the line to indicate it is a “jump” line and the entire line is highlighted when the cursor is on that line.

The keypad/display Information is organized into Menu groups: **Main Menu, Quick Menu, View/Set Unit Menu, Commission Unit Menu, Manual Control Menu, Service Menu, Unit Configuration Menu, and Alarm list Menus.**

**NOTE:** Only menus and items that are applicable to the specific unit configuration are displayed.

The **Main Menu** allows the user to enter a password, access the Quick Menu pages, view the current unit state, access the Alarm List Menu, as well as access to information about the unit. The **Quick Menu** provides access to status information indicating the current operating condition of the unit. The **View/Set Unit Menus** include basic menus and items required to setup the unit for general operation. These include such things as control mode, occupancy mode and heating and cooling setpoints. The **Commission Unit Menus** include more advanced items for “tuning” unit operation such as PI loop parameters and time delays. The **Manual Control Menu** allows service personnel to test unit specific operation manually. The **Unit Configuration Menu** allows the user to access to the unit specific configuration information. These generally do not needing changing or accessing unless there is a fundamental change to or a problem with the unit operation. The **Alarm Lists Menu** includes active alarm and alarm log information.

## Passwords

Various menu functions are accessible or inaccessible depending on the access level of the user and the password they enter, if any. There are four access levels, including: No Password, Level 2, Level 4, and Level 6, with Level 2 having the highest level of access. Without entering a password, the user has access only to basic status menu items. Entering the Level 6 password (5321) allows access to the Alarm Lists Menu, Quick Menu, and the View/Set Unit Menus group. Entering the Level 4 password (2526) allows similar access as Level 6 with the addition of the Commission Unit Menu, Manual Control, and Service Menu groups. Entering the Level 2 password (6363) allows similar access as Level 4 with the addition of the Unit Configuration Menu.

**NOTE:** Alarms can be acknowledged without entering a password.

The main password page is displayed when the keypad/display is first accessed, the Home Key is pressed, the Back Key is pressed multiple times, or if the keypad/display has been idle longer than the Password Timeout (default 10 minutes). The main password page provides access to enter a password, access the Quick Menu, view the current Unit State, access the alarm lists, or view information about the unit.

Figure 2: Password Main Page

▲	AHU 01	1/5
	Enter Password	▶
	Quick Menu	▶
	Unit State=_____	
	Alarm Lists	▶
	About This AHU	▶

The password field initially has a value \*\*\*\* where each \* represents an adjustable field. These values can be changed by entering the Edit Mode described below.

Figure 3: Password Entry Page

Enter Password	1/1
Enter Password	* * * *

Entering an invalid password has the same effect as continuing without entering a password. Once a valid password has been entered, the controller allows further changes and access without requiring the user to enter a password until either the password timer expires or a different password is entered. The default value for this password timer is 10 minutes. It is changeable from 3 to 30 minutes via the Timer Settings Menu.

## Navigation Mode

In the Navigation Mode, when a line on a page contains no editable fields, all but the value field of that line is highlighted - meaning the text is white with a black box around it. When the line contains an editable value field, the entire line is inverted when the cursor is pointing to that line.

When the navigation wheel is turned clockwise, the cursor moves to the next line (down) on the page. When the wheel is turned counter-clockwise, the cursor moves to the previous line (up) on the page. The faster the wheel is turned the faster the cursor moves.

When the Back Button is pressed the display reverts back to the previously displayed page. If the Back button is repeatedly pressed the display continues to revert one page back along the current navigation path until the "Main Menu" is reached.

When the Menu (Home) Button is pressed the display reverts to the "main page."

When the Alarm Button is depressed, the Alarm Lists Menu is displayed.

## Edit Mode

The Editing Mode is entered by pressing the navigation wheel while the cursor is pointing to a line containing an editable field. Once in the edit mode, pressing the wheel again causes the editable field to be highlighted. Turning the wheel clockwise while the editable field is highlighted causes the value to be increased. Turning the wheel counter-clockwise while the editable field is highlighted causes the value to be decreased. The faster the wheel is turned the faster the value is increased or decreased. Pressing the wheel again causes the new value to be saved and the keypad/display to leave the Edit Mode and return to the Navigation Mode.

## Service Timers

A user may override timers for a period of up to 240 minutes by setting the Service Timer to a non-zero number. When the Service Timer is not zero, the times listed below are set to the Service Time (Default = 20 seconds) instead of the normal values. This allows the unit to be run through its operating states without having to wait for the normal time delays to expire. These times revert to the standard values when the Service Timer counts down to zero or is set to zero by the user.

The affected times are:

- Cooling Stage Time
- Heating Stage Time
- Start Initial Time
- Recirculation
- ZeroOATime

## Rapid Start

The user may elect to initiate a rapid startup sequence at unit power up by setting the Rapid Start flag to Yes. When this flag is set to Yes, the Service Timer is set to 10 minutes whenever the power is reset to the controller.

# Keypad and Display

## Main Menu

The following is a description of the MicroTech menu structure. These menus and items can all be displayed with the keypad/ display. Menu items displayed will change based on the selected unit configuration.

Figure 4: Main Menu – Keypad/Display Menu Structure

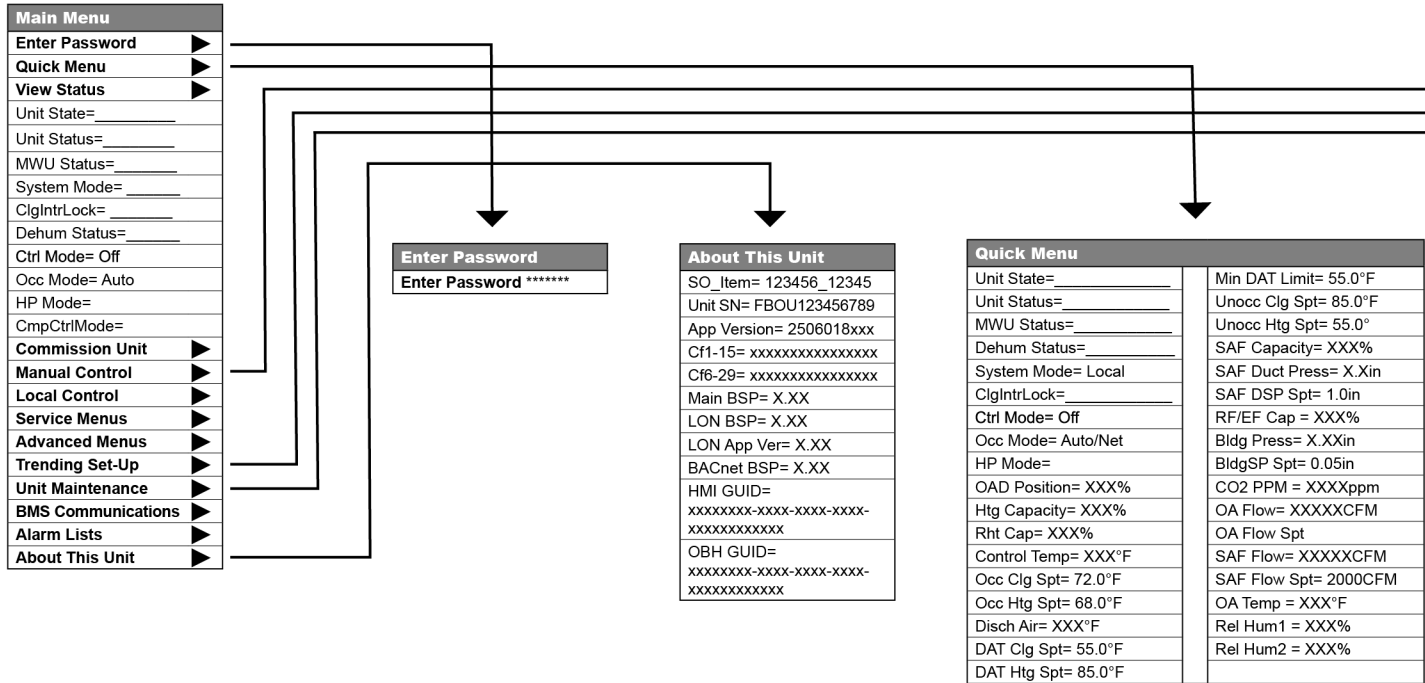

Manual Control	
Manual Ctrl= Normal	DFAuxHtgOut= Off
Supply Fan= Off	EHGBP1 Cap= 0%
SAF Cap Cmd= 0%	EHGBP2 Cap= 0%
Circ1 OAF1=Off	CW Valve= 0%
Circ1 OAF2=Off	Htg Valve= 0%
Exh Dampers= 0%	ModPrhtVlv= 0%
Exh Fan= Off	ModPrhtDmpr= 0%
EF Cap Cmd= 0%	PreheatVlv= Off
OADamper Pos= 0%	Htg Stg 1= Off
VCmp1= Off	Htg Stg 2= Off
VCmp1 Cmd= 0%	MHGRht Valve= 0%
C1FCmp1= Off	RH Bleed Valve= Off
CondSol1 Circ1= Off	ER Wheel= Off
C1 EVI Cap= 0%	ERBP Dmpr Cl= Off
C1 EVO cap= 0%	SCR Preheat= 0%
4WV1= Off	Aux Output= Off
4WV2= Off	RelDmprCls= Off

Trending Set-Up
Apply Chgs= No
Sample Time= 60s
TrendOnOff= On
Enable Trend1= Yes
Enable Trend2= No
Enable Trend3= No
Enable Trend4= No
Enable Trend5= No
EnaFreeTrend= No
AutoExpTime=1440 min
Export Data= No
Clear Trend= Done
TrendFull = Wrap

Unit Maintenance	
Operating Hours	▶
Air Filters	▶
Local Control	▶
Operating Hours	
Supply Fan= XXXXXh	FCmp1= XXXXXh
Exh Fan= XXXXXh	Dehumid= XXXXXh
Cooling= XXXXXh	Reheat= XXXXXh
Preheat= XXXXXh	ER Wheel= XXXXXh
Economizer= XXXXXh	ER Preheat= XXXXXh
Tnt Override= XXXXXh	UV Lights= XXXXXh
VCmp1= XXXXXh	
Air Filters	
MainFiltrSpt1= 0.5in	MainFiltrSw= _____
MainFiltrPres1= _____	FinalFiltrSpt= 0.5in
MainFiltrSpt2= 0.5in	FinalFiltrPres= _____
MainFiltrPres2= _____	FinalFiltrSw= _____
Local Control	
SAFCap= 0%	HeatingCap= 0%
CmpSystintrlk= Off	OADamperPos= 0%
4WVCmd= Off	EFCap= 0%
CmpCap= 0%	C1 EVI Cap= 0%
ReheatCap= 0%	C1 EVO cap= 0%

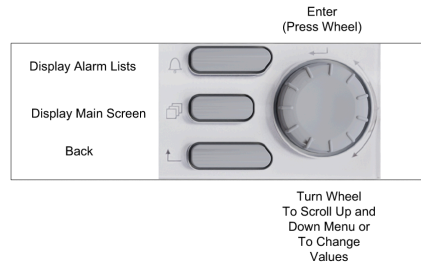

This navigation map represents all possible AHU menus and menu items. Not all menus and items shown here will appear on the HMI display depending upon the specific unit configuration. Those that do not appear are not applicable to this unit.

Figure 5: View Status Menu Structure

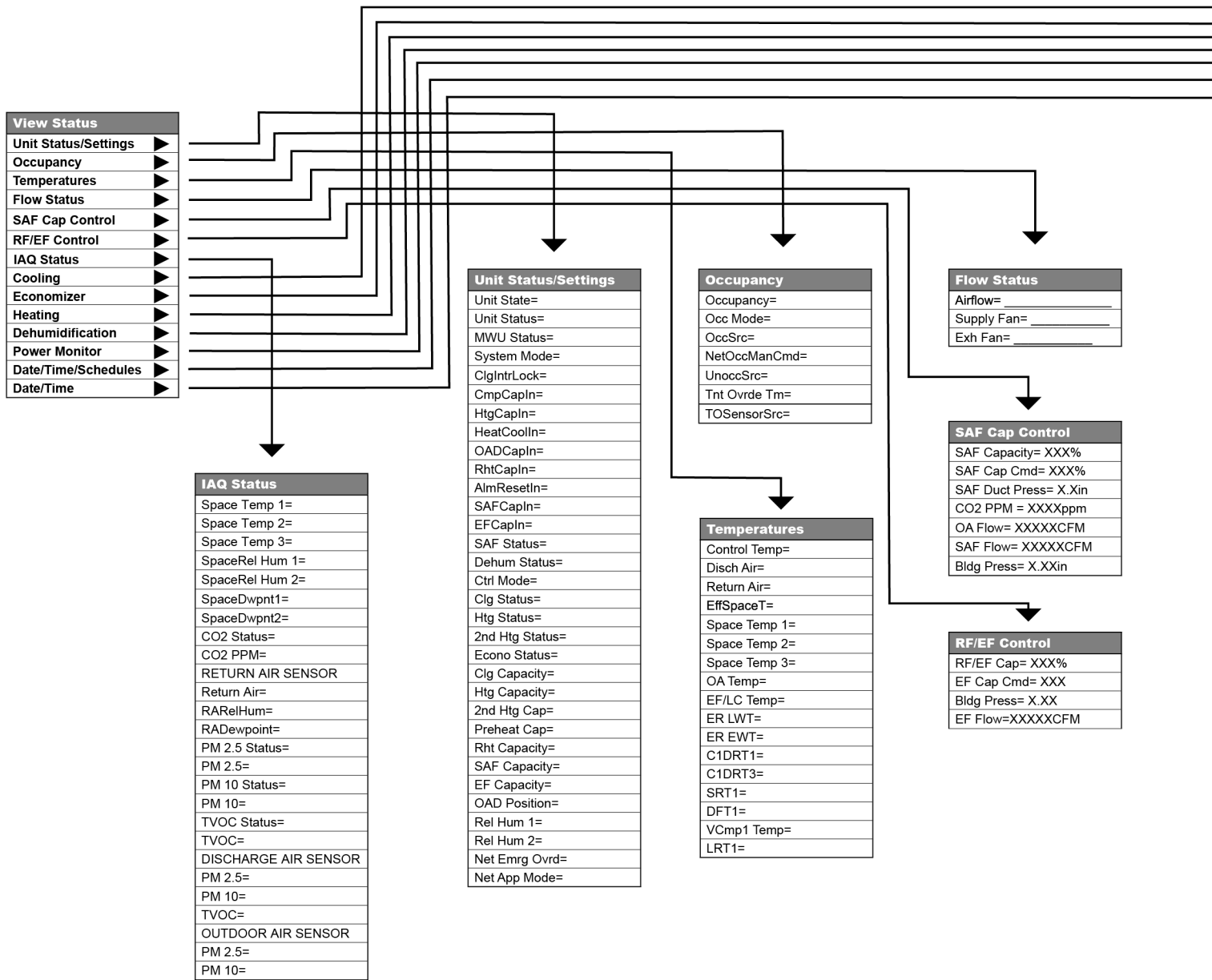



Cooling
Clg Capacity=
Clg Status=
REFRIG CIRCUIT 1
VCmp1=
VCmp1 Cap=
C1FCmp1=
PTS1=
PTD1=
SSH1=
DSH1=
Subcooling1=
Te1=
Tc1=
C1DRT1=
C1DRT3=
SRT1=

Dehumidification
Dehum Status=
Rel Hum1 = XXX%
Rel Hum2 = XXX%
Dewpoint1= XXX°F
Dewpoint2= XXX°F
Reheat Spt= XXX°F
Reheat Cap= XXX%

Power Monitor
TotalUnitkWh=
Unit kW=
PeakUnitkW=
AverageUnitkW=
L1L2Voltage=
L2L3Voltage=
L1L3Voltage=
L1kW=
L2kW=
L3kW=
L1Current=
L2Current=
L3Current=
NetSyskVAR=
kVAR L1=
kVAR L2=
kVAR L3=
kVA L1=
kVA L2=
kVA L3=
Power Factor=
Accm kVARh L1=
Accm kVARh L2=
Accm kVARh L3=
Accm kVARh=

Date/Time/Schedules
Time= hh:mm:ss
Date= MM/DD/YYYY
UTC Diff= -60
<b>Daily Schedule</b>
Mon= HH:MM-HH:MM
Tue= HH:MM-HH:MM
Wed= HH:MM-HH:MM
Thu= HH:MM-HH:MM
Fri= HH:MM-HH:MM
Sat= HH:MM-HH:MM
Sun= HH:MM-HH:MM
Hol= HH:MM-HH:MM
<b>Holiday Dates</b>
Hol 1= MMMDD/YY-MMDD/YY
Hol 2= MMMDD/YY-MMDD/YY
Hol 3= MMMDD/YY-MMDD/YY
Hol 4= MMMDD/YY-MMDD/YY
Hol 5= MMMDD/YY-MMDD/YY
Hol 6= MMMDD/YY-MMDD/YY
Hol 7= MMMDD/YY-MMDD/YY
Hol 8= MMMDD/YY-MMDD/YY
Hol 9= MMMDD/YY-MMDD/YY
Hol 10= MMMDD/YY-MMDD/YY
<b>One Event Schedule</b>
Beg=MMMDD/YY @ HH:MM
End=MMMDD/YY @ HH:MM
<b>Optimal Start</b>
Enable= No
Htg Rate= 0.4°F/min
Htg OAT= 35.0°F
Des Htg OAT= 0.0°F
Clg Rate= 0.4°F/mi
Clg OAT= 85.0°F
Des Clg OAT= 95.0°F
<b>Daylight Savings</b>
DLS Strt Month=Mar
DLS Strt Week=2ndWeek
DLS Endt Month=Nov
DLS Endt Week=1stWeek
DLS Enable=Auto
<b>Purge</b>
Max Purge= 0min

Date/Time
Time= hh:mm:ss
Date= MM/DD/YYYY
UTC Diff= -60min
<b>Daylight Savings</b>
DLS Strt Month=Mar
DLS Strt Week=2ndWeek
DLS Endt Month=Nov
DLS Endt Week=1stWeek
DLS Enable=Auto

Economizer
OAD Position= XXX%
Min OA Pos= XXX%
Econo Status =
FreeClgStatus =

Heating
Htg Capacity=
2nd Htg Cap=
Htg Status=
2nd Htg Status=
Htg Stg 1=
Htg Stg 2=
Htg Stg 3=
Htg Stg 4=
Preheat Cap=

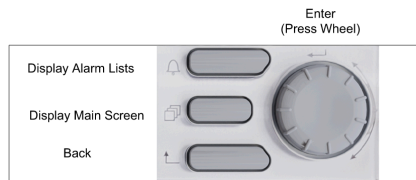

Enter  
(Press Wheel)

Turn Wheel  
To Scroll Up and  
Down Menu or  
To Change  
Values

This navigation map represents all possible AHU menus and menu items. Not all menus and items shown here will appear on the HMI display depending upon the specific unit configuration. Those that do not appear are not applicable to this unit.

Figure 6: Commission Unit Menu Structure

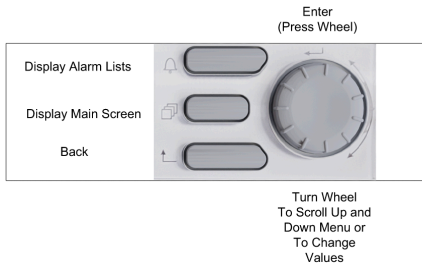
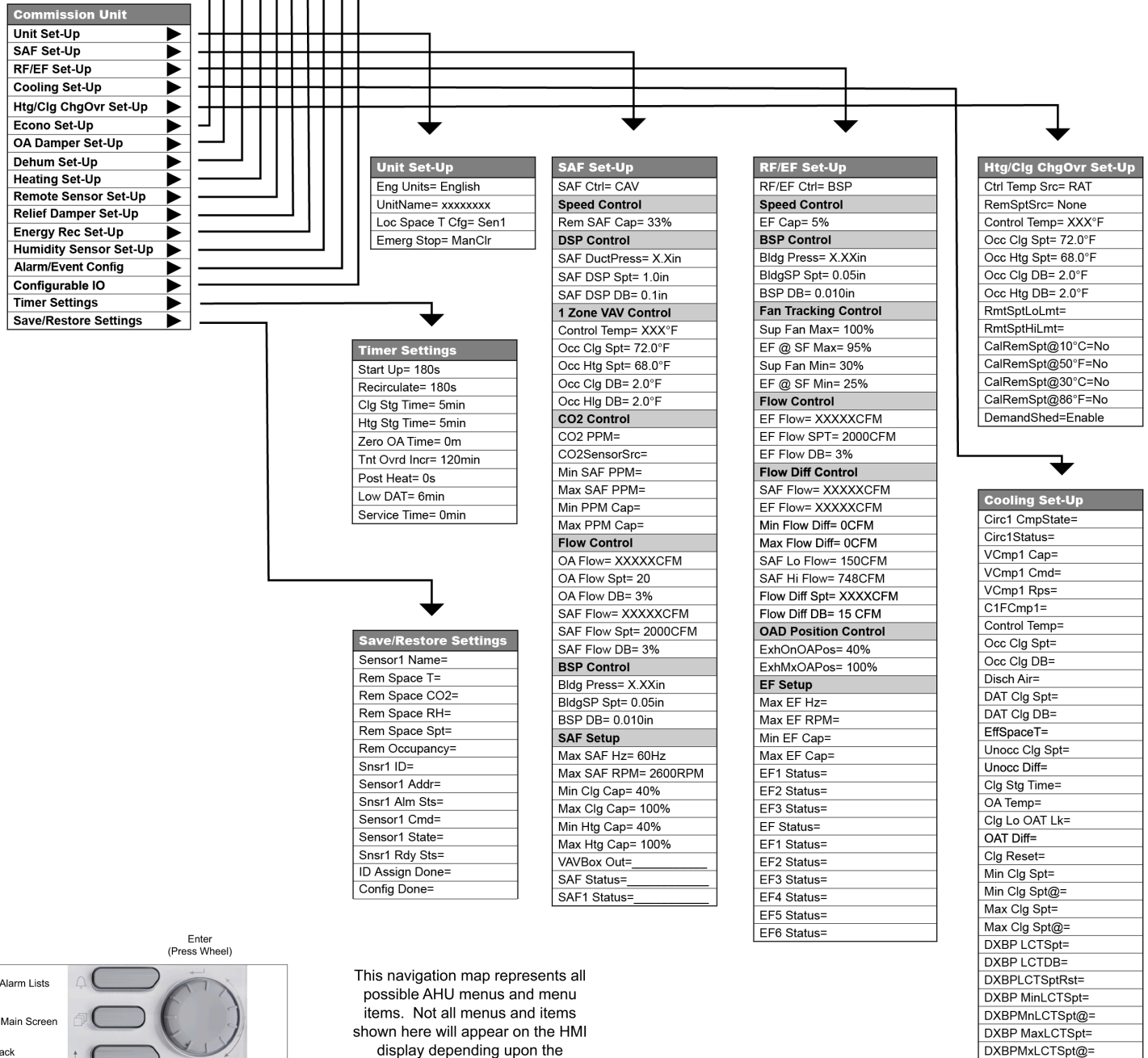

This navigation map represents all possible AHU menus and menu items. Not all menus and items shown here will appear on the HMI display depending upon the specific unit configuration. Those that do not appear are not applicable to this unit.

Econo Set-Up
Control Temp= XXX°F
Occ Clg Spt= 72.0°F
Occ Clg DB= 2.0°F
Disch Air= XXX.X°F
UseDATClgSpt=Yes
DAT Econ Spt= 55.0°F
DAT Econ DB= 2.0°F
Clg Stage Time= 5min
Econ Chgvr= EnthOAT
OA Temp= XXX°F
Chngvr Temp= 70.0°F
Econo Dif f= 2°F
Econo FDD= On
Econo Reset= None
Min Econ Spt= 55.0°F
Min Econ Spt @= 0
Max Econ Spt= 65.0°F
Max Econ Spt @= 100
Max OAT Lmt @= 75°F
Min OAT Lmt @= 70°F
Calibrate OAD=No
Pos Sw Open= 97%
Max Sw Diff= 3%
Pos Sw Close= 3%
Min Sw Diff= 5%
OAD Sw Status=
OAEOffset= 0.0°F
OADewpoint=
OARelHum=
OAEenthalpy=
RADewpoint=
RARElHum=
RAEnthalpy=
DATSptEnth=

OA Damper Set-Up
Vent Limit=
LoFlo VntLmt=
DCV Limit=
OAD Position=
Min OA Pos=
Min OA Src=
Network Reset
Network Reset=
Net Min OA=
EXT AI RESET
Ext AI Reset=
OA @ MinV/mA=
OA @ MaxV/mA=
Ext Singal=
CO2 Reset
CO2 Reset=
PPM @ DCV Lmt=
PPM @ Vnt Lmt=
CO2 PPM=
CO2SensorSrc=
PM Reset
PM 25 Reset=
PM25 @ DCVLmt=
PM25 @ VntLmt=
PM 25=
TVOC Reset
TVOC Reset=
TVOC @ DCVLmt=
TVOC @ VntLmt=
TVOC =
Flow Reset
OA Flow Reset=
OA Flow=
OA Flow Spt=
OA Flow DB=
BSP Reset
BSP OA Ovr=
Bldg Press=
BldgSP Spt=
BSP DB=

Heating Set-Up
Control Temp=
Occ Htg Spt=
Occ Htg DB=
Disch Air=
DAT Htg Spt=
DAT Htg Spt=
DAT Htg DB=
EffSpaceT=
Unocc Htg Spt=
Unocc Diff=
Htg Stg Time=
OA Temp=
Htg Hi OAT Lk=
OAT Diff=
Htg Reset=
Min Htg Spt=
Min Htg Spt @=
Max Htg Spt=
Max Htg Spt @=
Min DAT Ctrl=
Min DAT Limit=
MWU Sensor=
StgG1PriState=
StgG2PriState=
StgG3PriState=
StgGSplTState=
StgG1DiagCode=
StgG2DiagCode=
StgG3DiagCode=
ModGState=
ModGDiagCode=
ModGErrCode=
F&BP Method=
F&BP ChgOvrT=
EF/LC Temp=
PrhtLCTSpt=
PrhtLCTDB=

Humidity Sensor Set-Up
Hum Sensor 1=
Hum Sensor 2=
SpaceRH1Src=
SpaceRH2Src=
SpchumSensTyp=
Spchum MinSig=
Spchum MaxSig=
SpaceRel Hum 1=
SpaceDwprnt1=
SpaceRel Hum 2=
SpaceDwprnt2=
RARElHum=
RADewpoint=
OARElHum=
OADEwpoint=

Configurable I/O
Apply IO Chgs= No
X1 Cfg= AI_V
Input X1=
X2 Cfg= AI_V
Input X2=
X3 Cfg= AI_V
Input X3=
X4 Cfg= AI_V
Input X4=
X5 Cfg= AI_V
Input X5=
X6 Cfg= AI_V
Input X6=
X7 Cfg= AI_V
Input X7=
X8 Cfg= AI_V
Input X8=

Energy Rec Set-Up
Energy Rcvy= Yes
ER Wheel=
ER Whl Cap= XXX%
ER Whl CapCmd= XXX%
ER LWT= XXX°F
ER EWT= XXX°F
RARElHum=XXX%

Alarm/Event Config
Alarm Limits
Hi DAT Limit=
Lo DAT Limit=
Hi RAT Limit=
Alarm Out Config
Faults=
Problems=
Warnings=
AlmLogToSD=
Event Config
Show Events=
EventLogToSD=
Snapshot Config
SnapshotsToSD=

Relief Damper Set-Up
Exh Plen Press=X.XXXin
Ef fExh PSP Spt=
Rel Dmpr Cmd=
ExhPSP Lo Spt= 0.150in
ExhPSP Hi Spt= 0.350in
Exh PSP DB= 0.050in

Dehum Set-Up
Dehum Method= None
RelHum 1=XXX%
RelHum 2=XXX%
Hum 1 Spt=50%
Hum 2 Spt=50%
Dew point 1=XXX°F
Dew point 2=XXX°F
Dewpnt 1 Spt=XXX°F
Dewpnt 2 Spt=XXX°F
Rel Hum DB= 2%
Dew point DB= 2°F
LCT Set point= XXX°F
LCT Deadband=
LCT Spt Reset= None
Min LCT Spt= 45°F
Min LCT Spt@= 0.0
Max LCT Spt= 52.0°F
Max LCT Spt@= 100
LCTRstRHSpt=
LCTRstDptSpt=
Min Rheat Spt= 55.0°F
Max Rheat Spt= 65.0°F
Reheat Spt=
DAT Htg DB= 2.0°F
Unocc Dehum= No

Remote Sensor Set-Up
Snsr1 ID=
Snsr2 ID=
Snsr3 ID=
Commission Sts=
CommissionMode=
AllSnsrsReady=
Sensor1Sts=
Sensor2Sts=
Sensor3Sts=
Sensor1 State=
Sensor2 State=
Sensor3 State=
RmZn1.NameDsply
Sensor1 Name=
Rem Space T=
Rem Space CO2=
Rem Space RH=
Rem Space Spt=
Rem Occupancy=
Snsr1 ID=
Sensor1 Addr=
Snsr1 Alm Sts=
Sensor1 Cmd=
Sensor1 State=
Snsr1 Rdy Sts=
ID Assign Done=
Config Done=

# Field Wired Inputs

Rebel units are available with several control schemes which may require low voltage field wiring. Use the Unit Specific Electrical Schematics to determine which control connections will be required for installation. Check unit specific electrical documentation in the door of the unit's control panel.

**Table 1: Potential Field Connections and Locations on TB2 (Standard and Refrigeration Only Controls)**

Terminal Block Number	Description	Signal
STANDARD CONTROLS		
200	Power	24V AC
201	Signal for Tenant Override	Contact Closure
203	Return SD Into E-Stop	Contact Closure
204	Return SD Into E-Stop	Contact Closure
205	Field Provisions For E-Stop	Contact Closure
206	Field Provisions For E-Stop	Contact Closure
209	Power	24V AC Common
210	Space Temperature Sensor 1	Thermistor
212	Setpoint Adjustment, Wallstat	
214	CO2 / Ext OA Reset	0-10VDC
215	Alarm Output	24VAC Relay
216	Alarm Return	24VAC Relay
217	Fan Operation	24VAC Relay
236	Controller Common	
240	Local / Remote Status	Relay Output
240C	Local / Remote Status	Relay Output
297	Passive Ventilation Input	Contact Closure
2104C	A2L Alarm Status	Relay Output
2104	A2L Alarm Status	Relay Output
2105C	A2L Fault Status	Relay Output
2105	A2L Fault Status	Relay Output
REFRIGERATION ONLY CONTROL		
202	Condensate Overflow Switch	Contact Output
203	Condensate Overflow Switch	Contact Output
206	Field Provisions for E-Stop	
220	Freezestat Sensor Terminal 1	Contact Closure
221	Freezestat Sensor Terminal 2	Contact Closure
223	Heat Capacity Input	0-10VDC
231	Alarm Reset	Contact Closure
242	Cooling System Interlock (From Field)	Contact Closure
244	HP Heating / Cooling Mode Input	Contact Closure
245C	Defrost Status Output	Relay Output
245	Defrost Status Output	Relay Output
246	Reheat Capacity Input	0-10VDC
247	Cooling Capacity Input	0-10VDC
250	Cooling Actual Capacity Output	0-10VDC
267	Supply Fan Capacity Input	0-10VDC
275	Exhaust/Return Fan Capacity Input	0-10VDC
277	Outside/Return Air Damper Input	2-10VDC
232A	Main Filter Transducer/Switch	4-20mA / Contact Output
232B	Main Filter Transducer/Switch	4-20mA / Contact Output
232C	ERW Filter Transducer/Switch	4-20mA / Contact Output
232D	ERW Filter Transducer/Switch	4-20mA / Contact Output

Terminal Block Number	Description	Signal
2104C	A2L Alarm Status	Relay Output
2104	A2L Alarm Status	Relay Output
2105C	A2L Fault Status	Relay Output
2105	A2L Fault Status	Relay Output

**Table 2: Potential Field Connections and Locations on TB2A (Auxiliary Set)**

Terminal Block Number	Description	Signal
208E	Zone Humidity Sensor #1	4-20mA
208G	Zone Humidity Sensor #2	4-20mA
210E	Space Temperature Sensor 2	Thermistor
210G	Space Temperature Sensor 3	Thermistor
296A	Return Air SD Aux Contact	Relay Output
296B	Return Air SD Aux Contact	Relay Output
2100	Smoke Purge - Purge	Contact Closure
2101	Smoke Purge - Pressurize	Contact Closure
2102	Smoke Purge - Vent	Contact Closure
2103	Smoke Purge - Shutdown	Contact Closure

**Table 3: Potential Field Connections and Locations on TB2S (Auxiliary Sensor Output Blocks)**

Terminal Block Number	Description	Signal
229A	Airflow Signal	4-20ma / 0-10VDC
229B	Airflow Signal Common	4-20ma / 0-10VDC
281C	Thermistor Common	Thermistor
281	Discharge Air Temperature Signal	Thermistor
282	Return Air Temperature Signal	Thermistor
283	Leaving Coil Temperature Signal	Thermistor
284	Leaving Wheel Temperature Signal	Thermistor
285	Entering Wheel Temperature Signal	Thermistor
297	Outdoor Air Temp Signal	Thermistor
2120	Supply Fan Airflow Signal	4-20mA
2121	Supply Fan Airflow Common	4-20mA
2122	Return/Exhaust Fan Airflow Signal	4-20mA
2123	Return/Exhaust Fan Airflow Common	4-20mA
2124	Duct Static Pressure Signal	4-20mA
2125	Duct Static Pressure Common	4-20mA
2126	Building Static Pressure Signal	4-20mA
2127	Building Static Pressure Common	4-20mA
GND	Shield Ground	N/A

Figure 7: TB2 Diagram (Standard Controls)

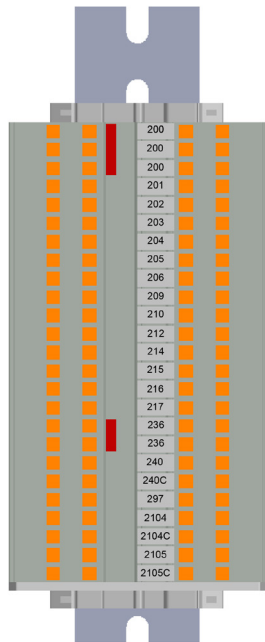

Figure 9: TB2A Diagram

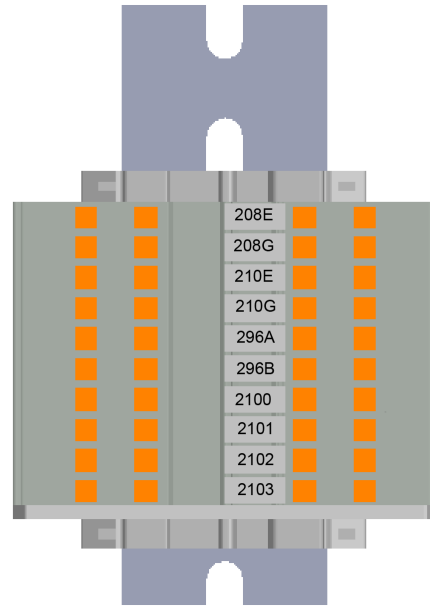

Figure 8: TB2 Diagram (Refrigeration Only Control)

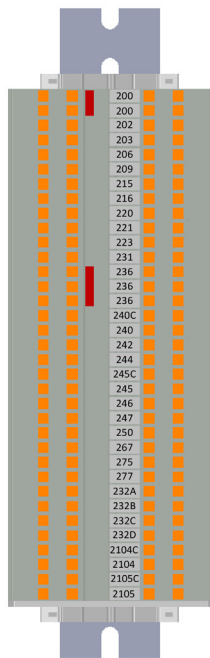
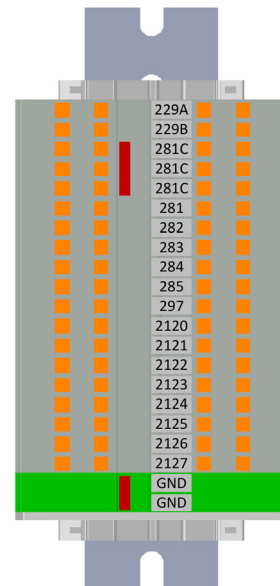

Figure 10: TB2S Diagram



## MicroTech Field Wiring

The MicroTech unit controller can be connected to a variety of field installed sensors.

- Space Sensor w/tenant override – Daikin Applied PN: 113117701
- DDC Space Sensor with Set point Adjust and Tenant Override - Daikin Applied PN: 910143408
- Combo DDC Temp and Humidity Sensor with Set point Adj and Tnt Ovrd - Daikin Applied PN: 910191961
- Communicating Network Space Sensors - Daikin Applied PN: 910279216 and 910278050
- Space Humidity Sensor - Daikin Applied PN: 910202119
- Wall Mounted CO2 Sensor - Daikin Applied PN: 107287012
- Duct Mounted CO2 Sensor - Daikin Applied PN: 910111672

## Space Temperature Sensors

The Rebel MicroTech works with 10kohm Type 2 thermistors and can support up to 3 space sensors. These sensors can drive cooling and heating based on the highest, lowest, or average space sensor reading.

**Figure 11: Space Temperature Sensors Wiring Diagram**

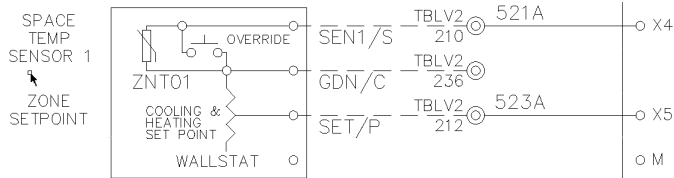

## Communicating Network Space Sensors

The MicroTech unit controller can be connected to a Network of the 3 space sensors as either a temperature sensor only or a temperature, Humidity and CO2 combo sensor. Each Sensor comes with a backlit LCD screen to show current space conditions, allow set point adjustment and commands.

- Network Temperature Sensor: Daikin Applied PN 910279216
- Network Combo Temperature Sensor: Daikin Applied PN 910278050

**Figure 12: Temperature Sensor**



The MicroTech can support up to 3 Network (QMX) sensors wired to the Process Bus terminals with a Daisy Chain Twisted pair.

**Figure 13: Wired Network Sensor Example**

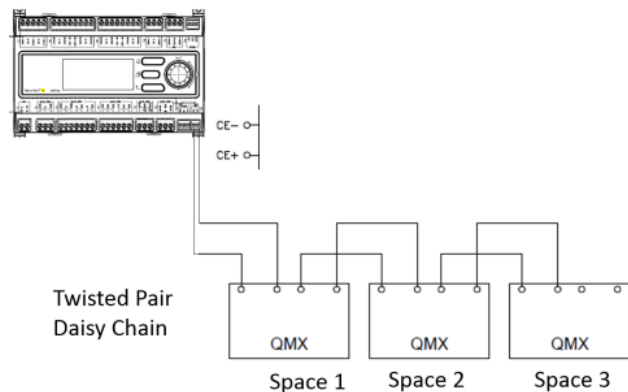

**NOTE:** The sensor is available in English units only and does not show SI units.

### IAQ/OA Flow

All units equipped with 100%, 0-30% OA or 0-100% OA Economizer dampers can be supplied with outdoor airflow measuring stations. Additionally, these variations can also be provided with a field mounted CO2 sensor for Demand Control Ventilation. CO2 sensors are wired to the TB2 in the low voltage panel at terminal 214. Demand Control Ventilation can also be performed using the Communicating Network sensors. See Table 93 on page 158.

Figure 14: CO2/OA Wiring Diagram

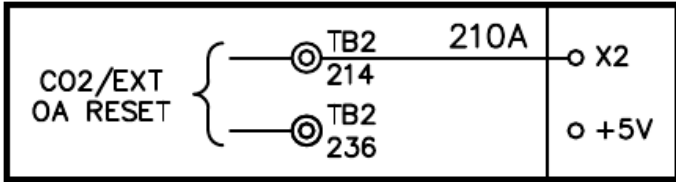

### Humidity Sensors

The MicroTech will support up to 2 remote, field wired remote mounted humidity sensors and two factory installed Outdoor and Return Air Humidity Sensors. Humidity sensors are used for economizer control, dehumidification control, and for monitoring via a Building Automation System. See Table 35 on page 89 and refer to Table 24 on page 60.

Figure 15: Humidity Sensor 1 Wiring Diagram

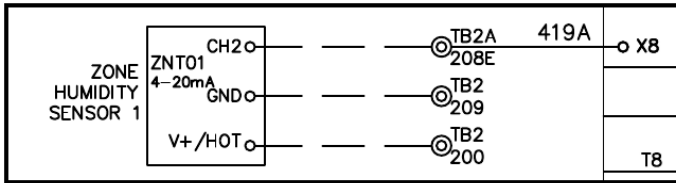
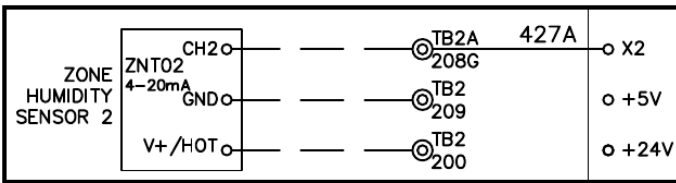

Figure 16: Humidity Sensor 2 Wiring Diagram



### Emergency Off Circuit

The Emergency Off Circuit will shut down the unit when the Digital Input is open. This circuit contains the smoke detector and field wired emergency off terminals.

Figure 17: Emergency Off Circuit Wiring Diagram

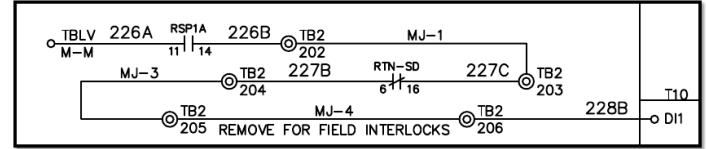

### Smoke Detectors

The Supply and Return Air Smoke Detectors have Auxiliary outputs from Pin 8 and 18 on the detector that are available on the TB2A Terminals. These contacts provide field status and are available on TB2A terminals 296A and 296B.

Figure 18: Smoke Detector Wiring Diagram

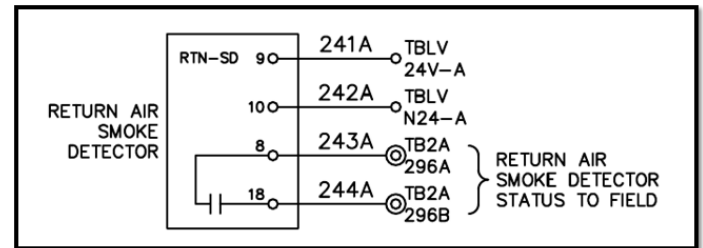

### Tenant Override

Figure 19: Tenant Override Wiring Diagram

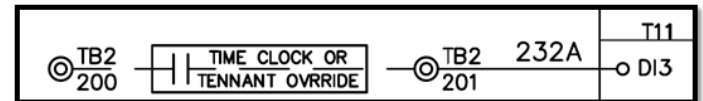

## Ventilation Override and Smoke Purge

The optional Ventilation Override Smoke Purge sequence provides four (4) field wire terminal block inputs that allow override of unit operation during an emergency control scenario. This control occurs with hard wired relays outside of the MicroTech. The inputs provide an override function to Ventilate, Pressurize, or Purge.

**Table 4: TB2A Terminal Sequence**

	<b>TB2A Terminal</b>	<b>Sequence</b>
Unit Shut Down	2103	The unit must be shut down to initiate the emergency override functions.
Ventilate	2102	When the ventilate contact is active, the Outdoor Air Damper is drive open to 100%.
Pressurize	2101	When the Pressurize contact is active, the Outdoor Air damper is driven open to 100% and the supply fan ramps to the SAF Vent Speed. This is adjustable in the Commissioning SAF Set-up menu.
Purge	2100	When the Pressurize contact is active, the Return Air damper is driven open to 100% and the Relief fan, (exhaust) ramps to the EF Vent Speed. This is adjustable in the Commissioning EF Set-up menu.

## Alarm Output and Auxiliary Output

MicroTech has an Alarm Output contact, DO9, that is available on TB2 Terminals 215,217 that provides a digital output anytime an alarm is active on the controller. MicroTech also has an Auxiliary Output contact, DO10, that is available on TB2 Terminals 216,217 that can be configured to provide a digital output anytime the fan is operational or to be used as a VAV active signal to drive boxes open during morning warm-up. To configure DO10, review Table 76 on page 144.

**Figure 20: Alarm/Auxiliary Outputs Wiring Diagram**

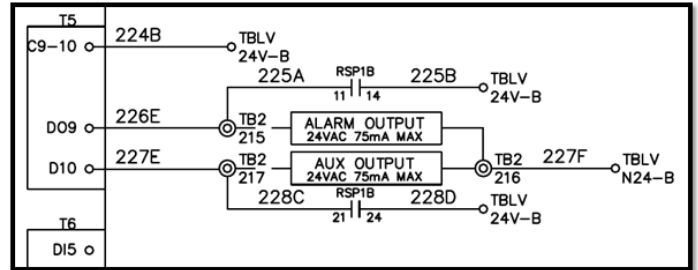



# Temporary Operations

## Manual Unit Operation

**⚠ WARNING**

Only qualified personnel should install, operate and service the equipment and that improper adjustment of settings and operation by an unqualified person could result in property damage, injury, or death.

**Manual Control** can be initiated during start up to control individual features of the air handling system independent of the control sequence. Place the unit into **Manual Control** mode through the MicroTech Keypad menu - Main Menu\Manual Control\Manual Ctrl = Manual. Once in manual control, you can activate fans and compressors manually, check damper operation, etc.

**NOTE:** Manual operation is not intended for extended operation beyond troubleshooting or initial start-up.

**Table 5: Manual Control**

Menu Display Name	Default	Range	Description
Manual Ctrl	Normal	Normal ManCtrl	Manual Ctrl is an adjustable item that allows the unit to enter manual control mode.
Supply Fan	Off	Off On	Supply Fan is an adjustable item that manually turns the fan on.
SAF Cap Cmd	0%	0-100%	SAF Cap Cmd is an adjustable item that manually drive the supply fan to a capacity.
Circ1 OAF1	Off	Off On	OAF1 Circ1 is an adjustable item that manually turns the outdoor fan 1 on on Circuit 1.
Circ1 OAF2	Off	Off On	OAF2 Circ 1 is an adjustable item that manually turns the outdoor fan 2 on on Circuit 1.
C1OAF1Cap	0%	0-100%	An adjustable item that manually controls capacity of OAF1 Circ1.
C1OAF2Cap	0%	0-100%	An adjustable item that manually controls capacity of OAF2 Circ1.
Exh Dampers	0%	0-100%	Exh Dampers is an adjustable item that sets the exhaust damper position if the unit is equipped with a modulating exhaust damper.
Exh Fan	Off	Off On	Exh Fan is an adjustable item that manually turns on the Exhaust Fan.
EF Cap Cmd	0%	0-100%	EF Cap Cmd is an adjustable item that manually sets the Exhaust Fan capacity.
OADamper Pos	0%	0-100%	OADamper Pos is an adjustable item that manually sets the outdoor air damper position capacity.
DXBP Dmpr Cmd	0%	0-100%	DXBP Dmpr Cmd is an adjustable item that manually sets the DX Bypass Damper position capacity.
VCmp1	Off	Off On	VCmp1 is an adjustable item that manually turns on Variable Compressor 1.
VCmp1 Cmd	0%	0-100%	VCmp1 Cmd is an adjustable item that manually sets the capacity of the Variable Compressor 1.
VCmp1 Cmd	0%	0% 100%	An adjustable item that manually sets VComp1 Cmd capacity to off or on.

Menu Display Name	Default	Range	Description
VComp1 Cmd	0%	0%	An adjustable item that manually sets VComp1 capacity to off, low speed or high speed.
		50%	
		100%	
CondSol1 Circ1	Off	Off	An adjustable item that manually turns circuit 1 condenser splitter valve 1 on/off.
		On	
CondSol2 Circ1	Off	Off	An adjustable item that manually turns circuit 1 condenser splitter valve 2 on/off.
		On	
CondSol3 Circ1	Off	Off	An adjustable item that manually turns circuit 1 condenser splitter valve 3 on/off.
		On	
C1 EVI Cap	0%	0-100%	An adjustable item that manually adjusts capacity of circuit 1 indoor expansion valve.
C1 EVO Cap	0%	0-100%	An adjustable item that manually adjusts capacity of circuit 1 outdoor expansion valve.
4WV1	Off	Off	An adjustable item that manually opens/ closes circuit 1 4-way valve.
		On	
DFAuxHtgOut	Off	Off	An adjustable item that manually opens/ closes defrost digital output, ie: outdoor condensate pan heater.
		On	
EHGBP1 Cap	0%	0-100%	EHGBP1 Cap is an adjustable item that manually sets the capacity of the Hot Gas Bypass Electronic Expansion Valve on Circuit 1.
EHGBP2 Cap	0%	0-100%	EHGBP2 Cap is an adjustable item that manually sets the capacity of the Hot Gas Bypass Electronic Expansion Valve on Circuit 2.
CW Valve	0%	0-100%	CW Valve is an adjustable item that manually sets the capacity of the chilled water control valve.
Heat Enable	Off	Off	Heat Enable is an adjustable item that manually turns on the primary heater.
		On	
Htg Valve	0%	0-100%	Htg Valve is an adjustable item that manually sets the capacity of the hot water or steam control valve.
SCR Capacity	0%	0-100%	SCR Capacity is an adjustable item that manually sets the capacity of the SCR electric heater.
F&BP Damper	0%	0-100%	F&BP Damper is an adjustable item that manually sets the capacity of the Face and Bypass Damper.
ModPrhtVlv	0%	0-100%	An adjustable item that manually controls the capacity of preheat hot water or steam valve.
ModPrhtDmpr	0%	0-100%	An adjustable item that manually controls the capacity of preheat damper
PreheatVlv	Off	Off	An adjustable item that manually controls on/off of preheat hot water or steam valve.
		On	
Htg Stg 1	Off	Off	Htg Stg 1 is an adjustable item that manually turns on stage 1 of heat in a staged heater.
		On	
Htg Stg 2	Off	Off	Htg Stg 2 is an adjustable item that manually turns on stage 2 of heat in a staged heater.
		On	
Htg Stg 3	Off	Off	Htg Stg 3 is an adjustable item that manually turns on stage 3 of heat in a staged heater.
		On	

Menu Display Name	Default	Range	Description
Htg Stg 4	Off	Off On	Htg Stg 4 is an adjustable item that manually turns on stage 4 of heat in a staged heater.
MHGRht Valve	0%	0-100%	MHGRht Valve is an adjustable item that manually sets the capacity of the modulating hot gas reheat valve.
RH Bleed Valve	Off	Off On	RH Bleed Valve is an adjustable item that manually sets the capacity of the modulating hot gas reheat bleed valve.
ER Wheel	Off	Off On	ER Wheel is an adjustable item that manually turns on the energy recovery wheel.
ER Whl CapCmd	0%	0-100%	ER Whl CapCmd is an adjustable item that manually sets the capacity the energy recovery wheel speed.
ERBP Dmpr Cl	Off	Off On	ERBP Dmpr Cl is an adjustable item that manually closes the Energy recovery wheel bypass damper.
ERBP Dmpr Op	Off	Off On	ERBP Dmpr Op is an adjustable item that manually opens the Energy recovery wheel bypass damper.
SCR Preheat	0%	0-100%	SCR Preheat is an adjustable item that manually sets the capacity of the SCR Preheat defrost coil.
Alm Output	Off	Off On	Alm Output is an adjustable item that manually turns on the alarm output.
Aux Output	Off	Off On	Aux Output is an adjustable item that manually turns on the Auxiliary output DO10.
EconStatusOut	Off	Off On	An adjustable item that manually turn on/off economizer status output.
RelDmprCls	Off	Off On	RelDampCls is an adjustable item that manually turns on the Relief Damper Close output.

## Temporary Operation for Heating and Cooling

For **Temporary Heating and Cooling** operation during the construction or prior to building occupancy follow these steps.

**NOTE:** This temporary control works on all units with a Return Air Opening (and not 100% OA configured equipment) and controls to maintain the return air temperature at the set point before space sensors or additional controls are available. It is not intended to directly control humidity or building pressure.

1. Be prepared to record the original settings on paper for each of the following sets. You will need to revert the settings to the defaults prior to final commissioning.
2. Configure for Zone Control: For Temporary Heating and Cooling operation you will need to configure the MicroTech for Zone Control operation using the keypad menu.
  - a. Enter Password 6363
  - b. Navigate: Main Menu\Advanced Menu\Unit Configuration (you will need to enable the advanced menu in the service menu)
  - c. Set Control Type = Zone Temperature Control (ZTC)
  - d. Scroll to the top save settings. The controller will cycle power
3. Configure for RAT: set temporary cooling or heating set point
  - a. Enter Password 6363
  - b. Navigate: Main Menu\Commission Unit\Htg/Clg ChgOvr Set-Up
  - c. Set Ctrl Temp Src = RAT
  - d. Set OccClg Spt = desired set point for temporary cooling
  - e. Set Occ Htg Spt= desired set point for temporary heating
  - f. Return to Main Menu
4. Set-Up OA Damper
  - a. Navigate: Main Menu\Commission Unit\OA Damper Set-Up
  - b. Set Vent Limit = 0%
  - c. Return to Main Menu
5. Configure for Cooling or Heating
  - a. Navigate: Main Menu\ Quick Menu
  - b. Set Ctrl Mode = CoolOnly for Cooling Operation OR Heat for Heating operation
  - c. Set Occ Mode = Occ.
6. Revert to original control settings once temporary operation is complete

# Unit Set-Up

## Unit Set-Up

The units of measure can be set to English or SI units. General unit set-up configurations are used to adjust the MicroTech controller's units of measure: **Unit Name**, **Space Temperature Configuration**, and **Emergency Stop** control.

### Unit Name

A customized **Unit Name** can be entered. This helps identify each unit when more than one unit is connected to a single remote HMI. Example: RTU-1

### Local Space Temperature Configuration

More than one **Local Space Temperature Sensor** can be connected to the MicroTech. This configuration sets which sensor will drive the unit operation; either Sensor 1, Sensor 2, sensor 3 or Minimum value, Maximum value, or Average value.

### Emergency Stop

The **Emergency Stop** configuration determines how the MicroTech will resume operation after an emergency off signal. "ManClr" requires a cycling of the power at the disconnect. When set to "AutoClr" the unit will resume operation once the emergency off signal disappears.

## Unit Set-Up Menu

**Table 6: Main Menu \ Commission Unit \ Unit Set-Up**

Menu Display Name	Default	Range	Description
Eng Units	English	English SI	Eng Units is an adjustable item to indicate if the unit is to display English or Metric units of measure.
Unit Name	-	-	Unit Name is an adjustable item that allows each controller to be given a unique name. This may be useful when multiple units are connected to a single remote HMI.
Loc SpaceT Cfg	Sens1	Min Max Avg Sens1 Sens2 Sens3	Loc SpaceT Cfg is an adjustable item that allows the user to select which space temperature sensor will be used as the effective space temperature sensor. MicroTech can be equipped with up to 3 space sensors, where the Min (lowest reading), Max (Highest Reading), Average (average reading) or a specific sensor can be used as the effective space sensor.
Emerg Stop	ManClr	ManClr AutoClr	Emerg Stop is an adjustable item that sets if the unit requires a manual reset after an emergency stop or if it will automatically restart once the emergency signal does not exist.

## Enable the Unit

### Control Mode

The unit heating and cooling can be set up for automatic heat/cool, heating only, cool only, or fan only operation based on a network signal by setting the **Control Mode** parameter to “Auto.” With the **Control Mode** parameters set to “Auto,” the heat/cool, cool only, heat only, fan only decision is determined by the Net App Mode. The Net App Mode is set by a signal. The following sections describe the five available Net App Mode selections.

**NOTE:** The Net App Mode has no effect on the unit operation unless the Control Mode parameter is set to “Auto.”

### Off

When the Net App Mode is set to “**OFF**,” the Unit Status is “Off Net” and the unit is completely disabled, including unoccupied heating (night set back) and unoccupied or unoccupied cooling (night set up) operation.

### Heat Only

When the Net App Mode is set to “**Heat Only**,” heating operation is allowed to operate as required to maintain the heating set points. Cooling operation is disabled (Cooling Status is “Off Net”).

### Cool Only

When the Net App Mode is set to “**Cool Only**,” cooling operation is allowed to operate as required to maintain the cooling set points. Heating operation is disabled (Heating Status is “Off Net”).

### Fan Only

When the Net App Mode is set to “**Fan Only**,” the fans are allowed to operate but cooling and heating operation is disabled (Cooling Status and Heating Status are “Off Net”).

### Heat Cool

When the Control Mode is set to “Heat/Cool,” both cooling and heating operation are allowed to operate as required to maintain the cooling and heating set points.

### Auto

When the Net App Mode is set to “**Auto**,” heating and cooling operation are allowed to operate as required to maintain the heating and cooling set points.

**NOTE:** Control Mode can be viewed and changed in the Main Menu, Quick Menu, and Unit Status/Setting Menu

# Occupancy

**Occupancy Mode** is a configurable item that determines the current unit mode. Settings can be, Occ, Occupied, Unocc (Unoccupied), TntOvrd (Tenant Override), or Auto/Net (Auto change based on network or schedule).

## Occupied Operation

During **Occupied Operation**, the unit starts and runs continuously, cooling, dehumidifying and heating as required to maintain the occupied setpoints.

## Unoccupied Operation

During **Unoccupied Operation** the unit operates normally except that the Minimum OA position is always set to zero so that the damper is closed to the outdoor air.

- **Unoccupied Cooling:** Unoccupied operation is initiated if the space sensor is reliable, the space temperature is greater than the Unoccupied Cooling Set point, and the Unoccupied Cooling Set point is set lower than its maximum setting. In this case, the unoccupied source indicates “UnoccClg”.
- **Unoccupied Heating:** Unoccupied operation is initiated if the space sensor is reliable, the space temperature is less than the Unoccupied Heating Set point, and the Unoccupied Heating Set point is set higher than its minimum setting. In this case, the Unoccupied Source indicates “UnoccHtg”.
- **Unoccupied Dehumidification:** Dehumidification may be initiated in the unoccupied mode only if Dehumidification Control is set to Always instead of Occupied on the keypad. When this is the case and the humidity goes high the unit transitions in the normal manner through Start up and Recirc to Fan Only and then into the Dehumidification Mode. In this case, the UnoccSrc= parameter indicates “Unocc Dehum”.

## Determining Occupancy Source

Occupancy can be driven by a number of sources: Network Schedule, Internal Schedule, a preprogrammed event, Manual Control of Occupancy, a remote wired switch, a Building Automation System or a Temperature Sensor Override.

- **Schedule:** Occupancy can be driven off of a schedule either through the network or using the internal schedule function on MicroTech.
  - **Network:** When occupancy is set to Net Schedule, this means that occupancy is being driven to occupancy due to a network schedule.
  - **Internal:** When occupancy is set to IntSchedule, this means that occupancy is being driven to occupancy due to the internal schedule in the unit controller.
  - **One Event:** When occupancy is set to OneEventSchedule, this means that occupancy is being driven to occupancy due to a preprogrammed, scheduled event in the unit controller.
- **Manual Occupancy:** Occupancy can be driven manually to occupied, at the MicroTech controller interface, via a contact closure of a switch or via a Building Automation network.
  - **Occupancy Mode:** Occ Mode is when the occupancy has manually been set to Occ at the unit controller.
  - **Remote Switch:** When the unit is in occupancy due to a field supplied external time clock or a tenant override switch in the form of a set of dry contacts is closed across terminals 200 and 201 on the unit field terminal block TB2.
  - **Network:** When an OccManCmd is shown for occupancy status, the network is sending a manual occupied signal.
- **Tenant Override:** Tenant override is when the unit occupancy status is overridden from unoccupied to occupied operation for a override timer, and adjustable timer from 0-300 min.
  - **TStat Tenant Override:** The TStat Tenant Override (TstatTO), status is occupancy override due to the tenant override button on the any zone thermostat being pushed and held for at least 1 second.
  - **ManTenant Override:** Manual Tenant Override (ManTO) status is occupancy override due to the unit is manually set to occupied at the unit controller and the override timer is set to a non-zero value.
    - Tenant Override can be set to not be activated by any space sensors by setting the TOTime = 0min and by setting the TOSensorSrc = None
    - The TOTime entry on the keypad can also be manually set to a non-zero value. In this case the value begins timing down from the edited value.
    - Tenant Override operation may be terminated by manually setting the Tenant Override parameter on the keypad to zero or by disabling the unit.

## Determining Unoccupied Source

Unoccupied operation is allowed when a valid space temperature sensor(s) is present.

- **Unoccupied Dehumidification:** Unoccupied operation is enabled with the Unocc Dehum in the Dehumidification set-up menu is set to Yes. In order for unoccupied operation to be performed a valid space humidity sensor must be connected to the unit and configured in the Humidity Sensor set up menu. During unoccupied dehumidification, the unit will activate the unit with the outside air damper closed and will start cooling plus dehumidification operation to control the space sensor relative humidity, or dew point set point. Refer to the Dehumidification section for details on configuring the dehumidification method, and sensor setpoints.
- **UnoccClg:** Unoccupied operation is initiated if the space sensor is reliable, the space temperature is greater than the Unoccupied Cooling Set point, and the Unoccupied Cooling Set point is set lower than its maximum setting. In this case, the unoccupied source indicates "UnoccClg".
- **Unocc Htg:** Unoccupied operation is initiated if the space sensor is reliable, the space temperature is less than the Unoccupied Heating Set point, and the Unoccupied Heating Set point is set higher than its minimum setting. In this case, the Unoccupied Source indicates "UnoccHtg".
- **Internal Optimal Start:** Unoccupied operation is enabled due to an internal optimal start schedule being activated. In this case, the Unoccupied Source indicates "IntOptStrt".
- **Network Optimal Start:** Unoccupied operation is enabled due to a network optimal start schedule being activated. In this case, the Unoccupied Source indicates "NetOpStrt".



## Occupancy Menu

Table 7: Main Menu \ View Status \ Occupancy

Menu Display Name	Default	Range	Description
Occupancy	-	Occ Unocc TntOvrd	Occupancy is a status only item that displays the current occupancy status. Occupancy can be one of three values, Occupied(Occ), Unoccupied(Unocc) and Tenant Override (TntOvrd).
Occ Mode	Auto/Net	Occ Unocc TntOvrd Auto/Net	Occ Mode is an adjustable item that sets the occupancy mode for manual occupied and unoccupied operation, or for automatic operation based on a time schedule input, or manual tenant override operation.
OccSrc	-	None NetSchd IntSchd OneEvnt RemoteSW NetManCmd OccMode TstatTO ManTO	OccSrc is a status only item which indicates the input source or function that is responsible for setting the Occupancy parameter to "Occ" or "TntOvrd".
NetOccManCmd	-	Occ Unocc TntOvrd Standby Auto	A status only item that displays the current Network Occupied Manual Command.
UnoccSrc	-	UnoccDehum Unocc Clg UnoccHtg IntOptStrt NetOptStrt IntPurge NetPurge None	UnoccSrc is a status only item which indicates the input source or function that is responsible for running the unit while the Occupancy parameter to "Unocc".
Tnt Ovrde Tm	0	0-300min	Tnt Ovrde Time is an adjustable item which indicates the amount of time remaining for unit operation since tenant override operation was activated.
TOSensorSrc	Any	None Sensor1 Sensor2 Sensor3 Any	TOSensorSrc is an adjustable item which indicates which space sensor can drive tenant override. MicroTech 4 can support up to 3 space sensors with tenant override.

## Scheduling

The unit can be scheduled for operation by using the following three methods:

- Unit internal time scheduling functions
- External time clock function
- Network time scheduling function

Provided the unit is not locally or remotely disabled, the unit operates when any of these scheduling functions is calling for occupied operation. Conversely, the unit enters the unoccupied mode when all of these scheduling functions are calling for unoccupied operation. Therefore, any unused scheduling functions should be set for continuous unoccupied operation.

The next four sections: “Controller Date and Time,” “Internal Daily Scheduling,” “Holiday Scheduling,” and “One Event Scheduling” describe functions related to the internal unit scheduling functions. These are followed by a section describing the optimal start function which can be used with internal scheduling and network scheduling. This is followed by two sections that describe the external time scheduling and network time scheduling functions.

### Date and Time

The controller uses the **Date and Time** to execute its internal scheduling functions. The current Time and Date will not be lost if the unit is turned off for up to forty-eight hours. The Time and Date are adjustable from the keypad. The Time of day can be set by entering the hour (00-23), minute (00-59), and second (00-59) into three fields of the Current Time. Note that MicroTech uses “military” time. The current Date can be set by entering the day (00-31), month (01- 12) and year (1999-2155) into the three fields of the Current Date.

### Internal Daily Scheduling

An **Internal Daily Schedule** provides one start time and one stop time for each of the seven days of the week and for holidays. When the Occ Mode= parameter is set to “Auto/Net”, and the unit is not disabled for other reasons, it starts and stops according to the controller internal schedule.

### Holiday Scheduling

The operator may select the days when start and stop times for holidays are used by selecting a start date and an end date for up to ten periods during the year using the **Holiday Scheduling** feature. Whenever a holiday period occurs, the controller uses the **Holiday Schedule** start and stop time for the period. For example, assume that Christmas Eve occurs on a Thursday. The building is shut down on both Christmas Eve and Christmas Day, but operates normally on the weekend. This holiday period would be scheduled by setting the Holiday Schedule to the default “no schedule” values “HH:MM- HH:MM” and setting the Holiday Period to “12/24/19 - 12/25/19”

## One Event Scheduling

**One-Event Scheduling** is provided so that one operating period can be scheduled without affecting the regular internal schedule. A start date/time and an end date/time can be set. The unit can be scheduled to operate during a specified period by using this feature. During the specified period defined by the One Event Beginning Date/Time and One Event Ending Date/Time parameters, the unit starts up and runs continuously regardless of any other time scheduling functions. For example, assume that a space served by the unit is occupied for a special event on March 12, 2019 from 5:00 p.m. to 10:00 p.m. when the normal time scheduling has the unit shut off after 4:00 p.m. on that date. This event can be accounted for by setting the One Event Beginning Date/Time to “3/12/19 @ 17:00:00” and the One Event Ending Date/Time to “3/12/19 @ 22:00:00.”

## External Time Scheduling

An **External Time Scheduling** clock can be used to schedule unit operation. This is accomplished by a field supplied external time clock signal in the form of a set of dry contacts wired across terminals 200 and 201 on the unit field terminal block TB2. In this case, all internal daily schedules should be set to “HH:MM-HH:MM” (default setting).

## Date/Time/Schedules Menu

**Table 8: Main Menu \ View Status \ Date/Time/Schedule**

Menu Display Name	Default	Range	Description
Time	-	00:00:00-23:59:59	Time: is an adjustable item that sets the current time (Hr:Mn:Sec).
Date	-	1/1/1970-1/31/9999	Date is an adjustable item that sets the current date. (M/D/Y).
UTC Diff	-.60min	-	UTC Diff is an adjustable parameter that can be set to indicate how the local time where the unit is situated differs from the Coordinated Universal Time.
<b>DAILY SCHEDULE</b>			
Mon	HH:MM- HH:MM	00:00-23:59	The Daily Schedule sets the start and stop times for each of the days of the week. One start and one stop time can be set for each day.
Tue			
Wed			
Thur			
Fri			
Sat			
Sun			
Hol			
<b>HOLIDAY DATES</b>			
Hol 1	MM/DD/99- MM/DD/99	00/00/00- 12/31/99	The Holiday Schedule is used to set the start and stop times for up to 10 different holidays.
Hol 2			
Hol 3			
Hol 4			
Hol 5			
Hol 6			
Hol 7			
Hol 8			
Hol 9			
Hol 10			
<b>ONE EVENT SCHEDULE</b>			
Beg	MM/DD/99 @ HH:MM	00/00/00 -12/31/99 @ 00:00 - 23:59	The One Event Schedule is used to set the start and stop times for one event.
End	MM/DD/99 @ HH:MM	00/00/00 -12/31/99 @ 00:00 - 23:59	
<b>DAYLIGHT SAVINGS</b>			
DLS Strt Month	Mar	NA Jan-Dec	DLS Strt Mon is an adjustable item that sets the month for daylight savings time to begin.
DLS Strt Week	2ndWeek	1stWeek 2ndWeek 3rdWeek 4thWeek 5thWeek	DLS Strt Week is an adjustable item that sets the week of the month for daylight savings time to begin.
DLS End Month	Nov	NA Jan-Dec	DLS End Mon is an adjustable item that sets the month for daylight savings time to end.

Menu Display Name	Default	Range	Description
DLS End Week	1stWeek	1stWeek 2ndWeek 3rdWeek 4thWeek 5thWeek	DLS End Week is an adjustable item that sets the week of the month for daylight savings time to end.
DLSEnable	Auto	Off Auto	DLS Enable is an adjustable item that sets whether or not daylight savings time is enabled.

## Optimal Start (Morning Warm-Up/Cool Down)

The **Optimal Start** sequence is used so the unit starts at the most efficient time before building occupancy. Optimal Start can be initiated based on an internal schedule or from a signal from a connected network. When Optimal Start is based on an internal schedule, the controller uses start history, outdoor air temperature and space temperature to determine when the unit should start. The unit may start up to four hours before the schedule occupancy time. When Optimal Start is based on network control, the network may write a time to occupancy to the unit to initiate the start time.

### Morning Warm-Up

**Morning Warm-Up** operates when the space temperature is below the Occupied or Unoccupied Heating Set point by  $\frac{1}{2}$  the Zone Htg Deadband. During Morning Warm-up operation the outside air damper is kept closed and the unit heating is used to warm-up the space while recirculating air. The timer, ZeroOATime, is set equal to the time to occupancy during optimal start so that the OA dampers will open at the start of occupancy. DAT units have a Morning Warm-Up set point available.

- **Zone Control Units:** When a Zone Control Unit (Ctrl Type=Zone) first starts in the morning, it enters the Heating operating state if the Control Temperature is below the Occupied Heating Set point by more than  $\frac{1}{2}$  the heating dead band. In this case, the Occupied Heating Set point is the “morning warmup set point”
- **DAT Control Units:** For Discharge Temperature Control units (Ctrl Type=DAC) there are two additional morning warmup related adjustable parameters; MWU Heating Set point and MWU Sensor. When a Discharge Temperature Control unit first starts in the morning it enters the Heating operating state if the sensor selected by the MWU Sensor parameter (RAT or Space) is below the MWU Heating Set point by more than  $\frac{1}{2}$  the Heating dead band. The MWU Sensor can also be set to None. If the MWU Sensor is set to None the MWU Heating Set point has no effect and the unit only enters heating based on the Occupied Set point in the normal manner.

### Morning Cool Down

**Morning Cool Down** operates when the space temperature is above the Occupied or Unoccupied Cooling Set point by  $\frac{1}{2}$  the Zone Cooling Deadband. During Morning Cool Down operation the outside air damper is kept closed and the unit operates cooling to cool the space down using recirculated air. The timer, ZeroOATime, is set equal to the time to occupancy during optimal start so that the OA dampers will open at the start of occupancy.

### No Optimal Start

If the space temperature is between the Occupied or Unoccupied Heating and Cooling setpoints, the unit will start at the occupancy time, and not when Morning Warm-Up or Cool Down operation is performed.

## Optimal Start Menu

**Table 9: Main Menu \ View Status \ Date/Time/Schedules**

Menu Display Name	Default	Range	Description
Enable	No	Yes No	Enable is an adjustable item that turns on the optimal start feature. Setting the value to yes will activate this function.
Htg Rate	0.4°F/min	0.0-1.0°F/min	Htg Rate is an adjustable item used by the controller in determining the amount time before occupancy to start when the Optimal Start parameter is set to "ON".
Htg OAT	35°F	-40-60°F	Htg OAT is an adjustable item used by the controller in determining the amount time before occupancy to start when the Optimal Start parameter is set to "ON".
Des Htg OAT	0°F	-40-60°F	Design Htg OAT is an adjustable item that sets the outdoor air temperature at which the heating system could just hold the load. The rate of temperature rise would equal zero.
Clg Rate	0.4°F/min	0.0-1.0°F/min	Clg Rate is an adjustable item that sets the rate of temperature drop in degrees per minute when the unit last started optimally in cooling.
Clg OAT	85°F	-40-140°F	Clg OAT is an adjustable item that sets the outdoor air temperature when the unit was last started optimally in cooling.
Des Clg OAT	95°F	-40-140°F	Design Clg OAT is an adjustable item that sets the outdoor air temperature at which the cooling system could just hold the load. Rate of temperature rise would equal zero.

## Purge Menu

**Table 10: Main Menu \ View Status \ Date/Time/Schedules**

Menu Display Name	Default	Range	Description
Max Purge	0min	0-300min	Max Purge is an adjustable item that sets the value of the maximum purge hold timer.

## Purge Operation

Purge Operation will provide pre-cooling to the space when the space OccStatus is Unocc by initiating unoccupied operation similarly to unoccupied cooling except that only economizer cooling will be used to cool the space. In this mode, mechanical cooling will be disabled (off Ambient). Purge Operation will be enabled prior to any scheduled start by the amount of time defined by the max purge time. Purge Operation is only valid if conditions are suitable for economizer operation and there is a space temperature sensor connected to the unit.

## Quick Menu

Items in the Quick Menu contain basic unit operating status and control set point parameters. The items shown in the Quick Menu are Read Only if a valid password has not been entered. The following are brief descriptions of the Quick Menu items. No password is required to view the Quick Menu.

**Table 11: Main Menu \ Quick Menu**

Menu Display Name	Default	Range	Description
Unit State	-	Off Start Recirc FanOnly MinDAT Htg Econo Clg	Unit State is a status only item which indicates the state of unit operation in which the unit is currently operating. The unit can be in any of the operating states shown.
Unit Status	-	Enable OffMan OffManCtrl OffNet OffAlmt OffRetry OffPassVnt	Unit Status is a status only item which indicates the status of operation in which the unit is currently operating. The unit status can be any of the status values shown.
MWU Status	-	Inactive Active	MWU Status is a status only item that indicates whether or not the unit is in the heating state due to MWU function.
Dehum Status	-	Inactive Active	Dehum Status is a status only item which indicates the status of operation of the dehumidification operation. Dehumidification operation can be active or inactive.
System Mode	Local	Local Remote	A status only item indicating the System Mode.
ClgIntr Lock	-	Open Closed	A status only item indicating the Cooling Inter-Lock status.
Cntrl Mode	Off	Off HeatOnly CoolOnly FanOnly HeatCool Auto/Net	Cntrl Mode is an adjustable item which sets the occupancy mode of the unit. The unit can be Heat Only, CoolOnly, Fan Only, HeatCool, or Auto/Net.
Occ Mode	Auto/Net	Occ Unocc TntOvr Auto/Net	Occ Mode is an adjustable item which sets the occupancy mode of the unit. The unit can be occupied, unoccupied, tenant override, or auto modes.
HP Mode	-	CoolOnly HeatCool	An adjustable item used to select the mode the refrigeration system can operate.

Menu Display Name	Default	Range	Description
CmpCtrlMode	-	Off Cooling Dehum Heating MinDAT	A status only item indicating the current Compressor Control Mode.
Clg Capacity	-	0-100%	Clg Capacity is a status only item which indicates the percentage of the unit maximum cooling capacity currently operating.
OAD Position	-	0-100%	OAD Position is a status only item which indicates the percentage that the outdoor air damper is currently open.
Htg Capacity	-	0-100%	Htg Capacity is a status only item which indicates the percentage of the unit maximum heating capacity currently operating.
2nd Htg Cap	-	0-100%	Secondary Heating Capacity is a status only item which indicates the percentage heating capacity currently operating.
Preheat Cap	-	0-100%	Pre-Heating Capacity is a status only item which indicates the percentage heating capacity currently operating.
Rht Cap	-	0-100%	Rht Cap is a status only item which indicates the percentage of the unit maximum reheat capacity the unit is currently operating at.
Control Temp	-	-461.2-525.2.0°F	Control Temp is a status only item which displays the current value of the "Control Temperature." The "Control Temperature" is defined as the temperature input selected by the Control Temperature Source parameter. For example, if the Control Temperature Source parameter is set to "Return," then the control temperature parameter reads the same value as the Return Air parameter.
Occ Clg Spt	72.0°F	0.0-100.0°F	Occ Clg Spt is a status only item which indicates the temperature in which the unit will go into the cooling mode of operation. Once a valid password has been entered this item becomes an adjustable item.
Occ Htg Spt	68.0°F	0.0-100.0°F	Occ Htg Spt is a status only item which indicates the temperature in which the unit will go into the heating mode of operation. Once a valid password has been entered this item becomes an adjustable item.
Disch Air	-	-50.0-250.0°F	Disch Air is a status only item which displays the current temperature reading from the unit's discharge air temperature sensor (DAT). This sensor is standard on all units.
DAT Clg Spt	55.0°F	40.0-100.0°F	DAT Clg Spt is a status only item which indicates the temperature that the DAT should be maintained at when it is in the cooling mode of operation. Once a valid password has been entered this item becomes an adjustable item.
DAT Htg Spt	85.0°F	40.0-140.0°F	DAT Htg Spt is a status only item which indicates the temperature that the DAT should be maintained at when in the heating mode of operation. Once a valid password has been entered this item becomes an adjustable item.
DAT Htg Spt	85.0°F	40.0-105.0°F	
Min DAT Limit	55.0°F	0.0-70.0°F	Min DAT Limit is a status only item which indicates the discharge air low limit temperature on CAV zone control units. Heating will be activated to maintain this setting when the discharge temperature falls below it during the Fan Only operating state. On VAV or CAV discharge control units, the minimum discharge temperature limit is the DAT Clg Spt. Once a valid password has been entered this item becomes an adjustable item.
Unocc Clg Spt	85.0°F	40.0-100.0°F	Unocc Clg Spt is a status only item which indicates the temperature in which the unit will go into the cooling mode of operation in the unoccupied occupancy state. Once a valid password has been entered this item becomes an adjustable item.
Unocc Htg Spt	55.0°F	40.0-140.0°F	Unocc Htg Spt is a status only item which indicates the temperature in which the unit will go into the heating mode of operation in the unoccupied occupancy state. Once a valid password has been entered this item becomes an adjustable item.
SAF Capacity	-	0-100%	SAF Capacity is a status only item which indicates the current capacity of the supply air fan.
SAF DuctPress	-	0.0-5.0in	SAF DuctPress is a status only item which displays the current supply duct static pressure reading.

Menu Display Name	Default	Range	Description
SAF DSP Spt	1.0in	0.2-4.0in	SAF DSP Spt is a status only item which displays the current supply fan duct static pressure set point. Once a valid password has been entered this item becomes an adjustable item.
EF Cap	-	0-100%	EF Cap is a status only item indicated the current capacity of the exhaust fans.
Bldg Press	-	-0.250-0.250in	Bldg Press is a status only item indicated the current building static pressure reading.
Bldg Press	-	-0.250-0.250in	
BldgSP Spt	0.050in	-0.250-0.250in	BldgSP Spt is a status only item which displays the current building static pressure set point. Once a valid password has been entered this item becomes an adjustable item.
CO2 PPM	-	0-5000ppm	CO2 PPM is a status only item which displays the current CO2 PPM reading.
OA Flow	-	0-60000 CFM	OA Flow is a status only item which displays the current OA Flow reading.
OA Flow Spt	2000CFM	0-60000 CFM	OA Flow Spt is a status only item which displays the current minimum outdoor air flow set point. Once a valid password has been entered this item becomes an adjustable item.
OA Flow	-	0-60000 CFM	A status only item indicating the Outside Airflow rate.
OA Flow Spt	2000CFM	0-60000 CFM	An adjustable set point for the outside Airflow, used to control the outside air damper to maintain the set airflow value.
SAF Flow	-	0-60000 CFM	SAF Flow is a status only item which displays the current supply air fan airflow reading.
SAF Flow Spt	2000CFM	0-60000 CFM	SAF Flow Spt is a status only item which displays the current supply air flow set point. Once a valid password has been entered this item becomes an adjustable item.
OA Temp	-	-50.0-200.0°F	OA Temp is a status only item which displays the current temperature reading from the unit mounted Outdoor air temperature sensor. This sensor is standard on all units.
Rel Hum1	-	0-100%	Rel Hum1 is a status only item that displays the current relative humidity reading from the optional relative humidity sensor at user defined location 1.
Rel Hum2	-	0-100%	Rel Hum2 is a status only item that displays the current relative humidity reading from the optional relative humidity sensor at user defined location 2.



# Unit State

The Unit State can operate in one of eight operational states. From an OFF state, the unit will always go into the “Start-Up” sequence. It will firstly enter the Start-Up state for 3 minutes (see Table 53 on page 112) before transitioning to the “Recirculation” state of operation for another 3 minutes. Once recirculation is complete, the unit will enter the Fan Only state of operation. Then, based on the control temperature source, (Ctrl Temp Src), selected in the HtgClg ChngOVr (see Table 14 on page 41) set up menu, a sensor will drive the unit into the correct state of the 4 remaining states - heating, cooling, economizer, or min DAT.

The current state will be displayed by the Unit State parameter in the Main Menu \ Quick Menu, or the Main Menu \ ViewStatus \ Unit Status/Settings Menu

Neither heating or cooling is provided when the unit is in the Fan Only state, with the exception of when dehumidification is active. The outdoor air dampers are open to the minimum position in the fan only when the fan ON time exceeds the Zero OA time.

Figure 21: Unit State Diagram

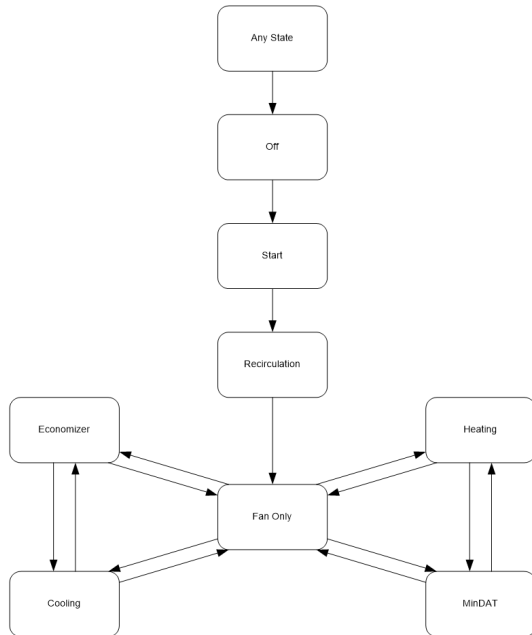

## Off

In the OFF operating state the fans are off, the outside air dampers are closed and cooling and heating are disabled. The unit is in the OFF state when it is not enabled, or when it is in unoccupied mode with no call for unoccupied operation. See “Occupancy Menu” on page 25 for how occupancy is determined.

## Start

When a unit is commanded to Start, it will always enter the START operating state for an adjustable time period (default is 180s, see Table 53 on page 112) before entering the Recirculation operating state. During start up operation, the fans remain OFF, the outdoor air dampers remain closed, and cooling and heating are disabled (except for 100% outdoor air heating start sequences). The Fan Operation output is turned ON (DO10, TB2 217) to allow shut off dampers and VAV boxes to be opened before the fan is turned ON.

## Fan Only

The unit enters the Fan Only operating state after the recirculation timer expires. Units configured for 100% outside air operation will transition directly from the Start up operating state to the Fan Only operating state. Neither heating or cooling is provided when the unit is in the Fan Only state, with the exception of when dehumidification is active. The outdoor air dampers are open to the minimum position in this state when the fan ON time exceeds the Zero OA time. Once entering the Fan Only state, the unit will then, based on the control temperature source, (Ctrl Temp Src), selected in the HtgClg ChngOVr set up menu, a sensor will drive the unit into the correct state of the 4 remaining states - heating, cooling, economizer, or min DAT (see Table 14 on page 41).

## Cooling

The unit enters the Cooling operating state when cooling is required and the economizer is disabled, not present, or already fully open. Cooling operation can be mechanical DX compressors or chilled water coils. To determine what unit configuration you have, review “Control Type” on page 39.

- Zone Temperature Control (ZTC) or Single Zone VAV (1ZnVAV): If the unit is configured for Zone Temperature Control(ZTC) or Single Zone VAV(1ZnVAV), the transition to cooling will occur when the following are true:
  - The control temperature rises above the occupied or unoccupied cooling set point by more than ½ the occupied or unoccupied cooling deadband.
  - The discharge air temperature is greater than the Min DAT limit by more than ½ the DAT heating deadband. This will prevent more cold air from being brought in when the DAT is already cold.
  - The economizer operation is disabled or not present.
- Discharge Air Temperature (DAC): If the unit is configured for Discharge Air Temperature Control the transition to Cooling will occur when the following are true:
  - The control temperature rises above the occupied

or unoccupied cooling set point by more than  $\frac{1}{2}$  the occupied or unoccupied cooling deadband. Note: for control temperature source none, the control temperature is the discharge air temperature.

- The discharge air temperature is greater than the DAT cooling set point by more than  $\frac{1}{2}$  the DAT cooling deadband.
- Post heat operation is complete.
- The economizer operation is disabled or not present.

## Economizer

If the unit is equipped with a 0-100% modulating Economizer and the conditions are suitable for free cooling, the unit attempts to satisfy the cooling load by using outdoor air before using mechanical cooling. Suitability for Economizer operation is determined by drybulb, comparative drybulb, or comparative energy/enthalpy. See "Economizer Control" on page 77 for details.

- **Zone Temperature Control (ZTC) or Single Zone VAV (1ZnVAV):** If the unit is configured for Zone Temperature Control or Single Zone VAV, the transition to Economizer will occur when the following are true:
  - The control temperature rises above the occupied or unoccupied cooling set point by more than  $\frac{1}{2}$  the occupied or unoccupied cooling deadband.
  - The discharge air temperature is greater than the Min DAT limit by more than  $\frac{1}{2}$  the DAT heating deadband. This will prevent more cold air from being brought in when the DAT is already cold.
  - The economizer operation is not disabled.
- **Discharge Air Temperature (DAC):** If the unit is configured for Discharge Air Temperature Control, the transition to Economizer will occur when the following are true:
  - The control temperature rises above the occupied or unoccupied cooling set point by more than  $\frac{1}{2}$  the occupied or unoccupied cooling deadband. Note: for control temperature source none, the control temperature is the discharge air temperature.
  - The discharge air temperature is greater than the DAT cooling set point by more than  $\frac{1}{2}$  the DAT cooling deadband.
  - Post heat operation is complete.
  - The economizer operation is not disabled.
- **Dehumidification:** When a unit is operating in dehumidification in Fan Only or Cooling operating states, dehumidification must finish operation and transition to cooling before the unit will enter economizer.

## Dehumidification

**Dehumidification** alone is not an operating state, but a mode of operation that can be active or inactive in the Fan Only and Cooling operating states when properly equipped. If the unit is equipped with a Liquid Sub-Cool Coil or Modulating Hot Gas Reheat Coil, dehumidification operation is allowed in the Fan Only and Cooling operating states. Dehumidification is activated based on a selectable humidity or dew point sensor input. Units can use up to two humidity or dew point inputs to determine dehumidification state. The user selects which location the humidity or dew point references for each position. Possible options are Outdoor or Space Humidity. The user can define if they want to use the maximum, minimum, or average of these two readings to drive dehumidification. Dehumidification is not allowed in Economizer, Heating, or Min DAT operating states.

## Heating

The unit enters the Heating operating state when the control temperature falls below the Occupied or Unoccupied Heating Set point by more than  $\frac{1}{2}$  the occupied or unoccupied heating deadband. During the Heating operating state, the outdoor air dampers are either 100% opening if the unit is a 100% outdoor air unit, or controlled to the minimum outside air position. Cooling is disabled.

- **Zone Temperature Control (ZTC) or Single Zone VAV (1ZnVAV):** If the unit is configured for Zone Temperature Control(ZTC) or Single Zone VAV(1ZnVAV), the transition to heating will occur when the following are true:
  - The control temperature falls below the occupied or unoccupied heating set point by more than  $\frac{1}{2}$  the occupied or unoccupied heating deadband.
  - The discharge air temperature is less than the Min DAT limit by more than  $\frac{1}{2}$  the DAT heating deadband.
  - Dehumidification is not active.
  - The economizer operation is disabled or not present.
- **Discharge Air Temperature (DAT):** If the unit is configured for Discharge Air Temperature control, the transition to Heating will occur when the following are true:
  - The control temperature falls below the occupied or unoccupied heating set point by more than  $\frac{1}{2}$  the occupied or unoccupied cooling deadband. Note: for control temperature source none, the control temperature is the discharge air temperature.
  - The Discharge Air Temperature is less than the DAT heating set point by more than  $\frac{1}{2}$  the DAT heating deadband.
  - Dehumidification is not active.
  - The Economizer operation is disabled or not present.

## Special Gas Heat Start-Up for 100% OA

A **Special Gas Heat Start Up** sequence is used for 100% outdoor air units with gas heat. The special start sequence applies to both Zone Control and DAT Control units. If heat is required at unit start up, the furnace enters a special burner startup sequence as the unit enters its Startup operating state. Pre-firing the burner allows the gas heat pre-purge sequences to occur and the burner to fire and warm up so that tempered air is available immediately when the fans start.

- **Initiation 100% OA Zone Control:** The 100% OA gas heat sequence is initiated at startup if the control temperature is less than the Effective Occupied or Unoccupied Heating Setpoint by  $\frac{1}{2}$  of the Heating deadband, or the OAT is less than the Min DAT Limit by the amount of the DAT heating deadband.
- **Initiation 100% OA DAT Control:** The 100% OA gas heat sequence is initiated at start up if the Min DAT Ctrl parameter is set via the keypad and the OAT is less than the DAT Clg Spt by the amount of the DAT heating deadband.
- **Special Start Up Sequence:** Initiated during the Start Up operating state, the fans remain off, and the main gas valve is energized so that the burner starts during the Warm up Time (default =40s) and operates at low fire. At the end of the warmup time, the modulating gas valve is set to a position based on the calculated application requirements. Once the gas valve is set to the calculated position, a HeatUpDelay starts (default =240s) to allow the heat exchanger to heat up. After this delay, since the unit is 100% Outside Air, the unit immediately transitions from Startup to the Fan Only state. As soon as the unit enters the Fan Only state, the unit will immediately transition to the Heating state or MinDAT.

## Min DAT

If heating is enabled and there is no heating load (normally Fan Only operating state), the controller activates the units heating equipment as required to prevent the discharge air temperature from becoming too cool if the Min DAT Ctrl Flag is set to yes via the Main Menu \ Commission Unit \ Heating Set-Up. The unit enters the MinDAT operating state during occupied operation when neither cooling or heating is required based on the HtgClgChgOvr function, but based on the if the discharge air temperature falls below a minimum discharge air limit. If the discharge air temperature falls below the minimum discharge air limit by more than half the discharge heating deadband, the unit operating state changes from Fan Only to Min DAT. The unit transitions out of the Min DAT operating state once the discharge air temperature is above minimum discharge temperature limit and the heating capacity has been at its minimum position for the duration of the heating stage timer.

**NOTE:** On discharge air control and single zone VAV units, the DAT cooling set point parameter in the Cooling Setup menu acts as the minimum discharge temperature limit. On Zone Control units, the Min DAT limit parameter in the Heating Set-Up menu (Main Menu \ Commission Unit \ Heating Set-Up \ MinDAT Limit) acts as the minimum discharge temperature limit.

The unit will not be allowed to transition to MinDAT if Dehumidification is active. The unit will transition to Fan Only operation if the dehumidification becomes active while in the MinDAT state.

## Unit Status/Settings

The “Unit Status Settings” menu provides a summary of basic unit status and control items. This menu summarizes the current operating state of the unit, giving the operating state the unit is in, along with the current capacity level of that operating state.

**Table 12: Main Menu \ View Status \ Unit Status \ Settings**

Menu Display Name	Default	Range	Description
Unit State	-	Off Start Recirc FanOnly MinDAT Htg Econo Clg	Unit State is a status only item which indicates the state of unit operation in which the unit is currently operating. The unit can be in any of the operating states shown.
Unit Status	-	Enable OffMan OffManCtrl OffNet OffAlmtry OffPassVnt	Unit Status is a status only item which indicates the status of operation in which the unit is currently operating. The unit status can be any of the status values shown.
MWU Status	-	Inactive Active	MWU Status is a status only item that indicates whether or not the unit is in the heating state due to MWU function.
System Mode	Local	Local Remote	System Mode is a status only item which indicates the current operating status.
ClgintrLock	-	Open Closed	A status only item which indicates the current state of the Cooling Interlock.
CmpCapIn	-	0-100%	A status only item which indicates the current state of the Compressor Capacity Input.
HtgCapIn	-	0-100%	A status only item which indicates the current state of the Compressor Heating Capacity Input.
HeatCoolIn	-	Cool Heat	A status only item which indicates the current state of Heating/ Cooling input.
OADCapIn	-	0-100%	A status only item which indicates the current state of the Outside Air Damper Capacity Input.
RhtCapIn	-	0-100%	A status only item which indicates the current state of the Reheat Capacity Input.
AlmResetIn	-	Normal Clear	A status only item which indicates the current state of the Alarm Reset Input.
SAFCapIn	-	0-100%	A status only item which indicates the current state of the Supply Fan Capacity Input.
EFCapIn	-	0-100%	A status only item which indicates the current state of the Exhaust Fan Capacity Input.
SAF Status	-	Off On	A status only item which indicates the current state of the Supply Fan on/off.
Dehum Status	-	Inactive Active	A status only item which indicates the current state of Dehumidification.

Menu Display Name	Default	Range	Description
Cntrl Mode	Off	Off HeatOnly CoolOnly FanOnly HeatCool Auto/Net	Cntrl Mode is an adjustable item which sets the occupancy mode of the unit. The unit can be Heat Only, CoolOnly, Fan Only, HeatCool, or Auto/Net.
Occ Mode	Auto/ Net	Occ Unocc TntOvrd Auto/Net	Occ Mode is an adjustable item which sets the occupancy mode of the unit. The unit can be occupied, unoccupied, tenant override, or auto modes.
Clg Status	-	Enabled None OffAmb OffAlm OffNet OffMan CfgErr	Clg Status is a status only item which indicates whether or not mechanical cooling is currently allowed. If cooling is disabled, the reason is indicated.
Htg Status	-	Enabled None OffAmb OffAlm OffNet OffMan OffDehum NA	Htg Status is a status only item which indicates whether or not heating is currently allowed. If heating is disabled, the reason is indicated.
Htg Status	-	Enabled None OffAmb OffAlm OffNet OffMan OffDehum NA	A status only item which indicates the current state of Heating.
2nd Htg Status	-	Enabled None OffAmb NA OffNet OffMan NA	A status only item which indicates the current state of the 2nd Heating Status.

Menu Display Name	Default	Range	Description
Econo Status	-	Enabled None OffAmb OffAlm OffNet OffMan OffDehum	Econo Status is a status only item which indicates whether or not the economizer is currently enabled. If economizer is enabled, the reason is indicated.
Clg Capacity	-	0-100%	Clg Capacity is a status only item which indicates the percentage of the unit maximum cooling capacity currently operating.
Htg Capacity	-	0-100%	Htg Capacity is a status only item which indicates the percentage of the unit maximum heating capacity currently operating.
2nd Htg Cap	-	0-100%	A status only item indicating the current secondary Heating source Capacity.
Preheat Cap	-	0-100%	A status only item which indicates the current state of the preheater capacity.
Rht Cap	-	0-100%	Reheat Cap is a status only item which indicates the percentage of the unit maximum reheat capacity currently operating.
SAF Capacity	-	0-100%	SAF Capacity is a status only item which indicates the current capacity of the supply air fan.
EF Capacity	-	0-100%	EF Capacity is a status only item indicated the current capacity of the exhaust fans.
OAD Position	-	0-100%	OAD/Economizer Cap is a status only item which indicates the percentage that the outdoor air damper is currently open.
Rel Hum 1	-	0-100%	Rel Hum 1 is a status only item that displays the current relative humidity reading from the optional relative humidity sensor at user defined location 1.
Rel Hum 2	-	0-100%	Rel Hum 2 is a status only item that displays the current relative humidity reading from the optional relative humidity sensor at user defined location 2.
Net Emrg Ovrđ	Normal	Normal Off	Net Emrg Ovrđ is an adjustable item which indicates if the unit was shut down in an emergency situation via a network command.
Net App Mode	Auto	Off HeatOnly CoolOnly FanOnly HeatCool Auto NA	Net App Mode is a network adjustable item which indicates that the unit is set for network off, cooling only, heating only, fan only or auto heating/cooling operation via a network signal. This item has no affect on the unit operation unless the Ctrl Mode item is set to "Auto".

## Control Type

### Temperature Control Configurations

**Temperature Control** is based on a Control Type that may be set to Zone, DAT Control, or Single Zone VAV. The setting will be based on the system and application the rooftop equipment is configured to serve.

### Zone Temperature Control (ZTC)

When the Control Type is set to **Zone Temperature Control**, heating, compressors, and the economizer are controlled to maintain the temperature of the zone at a desired set point. This configuration is used on units equipped with constant volume supply fans. Compressors and heating stages are staged to maintain space temperature. The number of compressors is decreased when it is too cold and increased when it is too hot subject to stage timers. The number of heat stages is decreased when it is too hot and increased when it is too cold subject to stage timers.

### Discharge Air Control (DAC)

When the Control Type is set to **DAC**, heating, compressors, and the economizer are controlled to maintain the discharge air temperature at a desired set point. This configuration is typically used on units equipped with variable air volume supply fans.

### Single Zone VAV (1ZnVAV)

When the Control Type is set to **Single Zone VAV**, heating, compressors, and the economizer are controlled to maintain the discharge air temperature at the desired set point, while the variable volume supply fan is modulated to maintain the temperature of the zone at the desired heating and cooling setpoints. In heating mode, the supply fan capacity is increased as the zone temperature falls and decreased as the zone temperature rises.

To determine which control configuration your unit is configured for, review “Unit Configuration” on page 138.

## Heating/Cooling Changeover

### Control Temperature Source

When the control temperature is below the occupied or unoccupied heating set point by more than ½ the deadband (point A), heating operation is enabled. Heating operation then remains enabled until the control temperature begins to rise and rises above the occupied or unoccupied heating set point by more than ½ the deadband (point B), at which point heating operation is disabled and the unit enters the fan only (or Min DAT) operating state. If the control temperature rises above the occupied or unoccupied cooling set point by more than ½ the deadband (point C) cooling operation is enabled. Cooling operation remains enabled until the control temperature begins to fall below the occupied or unoccupied cooling set point by more than ½ the deadband (point D), at which point the unit returns or fan only (or Min DAT) operating state.

Figure 22: Heating/Cooling Control Temperature

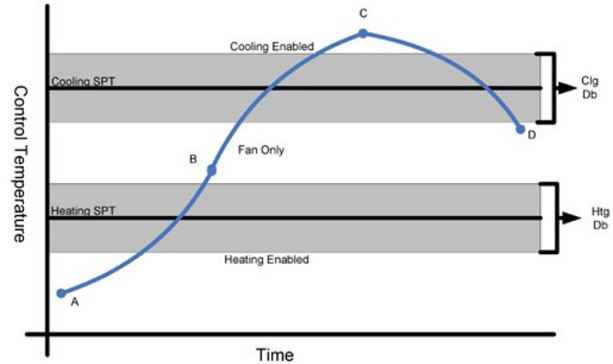

The “Control Temperature” is defined as the unit temperature input used to make the heat/cool changeover decision. This determines whether or not cooling or heating is enabled. The **Control Temperature Source** (Cntrl Temp Src) can be selected as RAT, OAT, Space, None or Network. The control temperature source selected will vary by application and temperature control configuration.

Table 13: Control Temp Source Quick Reference Table

Source	Mixed Air-Econo, 0-30			100% OA	
	Zone Control	DAT Control	Single Zone VAV	DAT Control	Zone Control
OAT	NA	NR	NA	R	NA
RAT	A	R	A	NR	A
Space	R	NR	R	NR	R
None	NA	A	NA	NR	NA

A - Available  
 R - Recommended  
 NA- Not Available  
 NR- Not Recommended

## Space Temperature Control – Zone Control

A unit configured for **Space Temperature Control (Zone Control)** operates the cooling and heating capacities to either maintain the Occupied or Unoccupied Cooling Set point using economizer and/or Mechanical Cooling or the Occupied or Unoccupied Heating SetPoint using the heating equipment.

- Space- Space is the most common and ideal change over source temperature for Zone control units. The MicroTech 4 controller can handle up to three space temperature sensor inputs and the min, max, average or a specific sensor can be used for control. Review “Unit Set-Up Menu” on page 21 for multiple space sensor operation and settings.
- RAT- Return is an ideal change over source temperature for zone control units that do not have a space sensor available.
- None, and OAT are not allowed for this configuration.

## Discharge Air Temperature Control

In general, a unit configured for discharge air temperature control (DTC) either operates to deliver the cooling discharge air temperature set point using economizer and or mechanical cooling or the heating discharge air temperature set point using the heating equipment. Cooling and heating never operate simultaneously. The unit state in a **Discharge Air Temperature Control** can be operated to change between cooling, fan only, and heating based on RAT, OAT, Space or None. Units operating in discharge air control are typically serving multiple zones through VAV boxes or are operating as a dedicated outside air unit.

### **DAT Control – Multi-Zone VAV**

Units serving VAV systems typically use the control temp source as Return Air Temperature or None to transition states.

- **RAT:** Return air is typically used when the zones the unit serves are not extremely diverse in unit state, when the transition to heat is relatively the same across the served zones and the rooftop is not the primary zone control heat source. Each zone may have base board, or heat in each VAV box.
- **None:** Control temp source as None is used when the VAV box distribution is diverse in state and load. In this case control temp source None, the unit no longer “changes over” between heating and cooling in the normal manner. Instead it acts as if it is always in the “cooling” mode of operation controlling to the discharge air cooling set point. In this case the unit operating state will vary between Cooling, Fan Only and Min DAT (heating) in order to maintain the discharge air cooling set point. The unit will only enter the Heating operating state and control to the discharge heating set point for morning warm up purposes.
- **Space and OAT** are not commonly used as the control temp in VAV systems.

### **DAT Control – Dedicated Outside Air Systems**

Units serving as a Dedicated outside air system are typically configured for discharge air temperature control with a control temperature source as outdoor air temperature (OAT).

- **OAT:** Outdoor air temperature is the ideal change over source temperature for DOAS because it links unit state to load.
- **RAT, Space, None:** Control Temp Source None, Space, and RAT is not recommended for DOAS applications because unit state may transition to an improper mode of operation for the weather resulting in heating in summer and fan only in winter. These poor transitions will lead to nuisance alarms and poor control.

## Single Zone VAV - 1ZnVAV

A unit configured for single zone VAV operates to deliver the cooling discharge air temperature set point using economizer and/or mechanical cooling or the heating discharge air temperature set point using the heating equipment. Cooling and heating never operate simultaneously. The unit state as a **Single Zone VAV** can be operated to change between cooling, fan only, and heating based on RAT or Space.

- **Space:** Space is the most common and ideal change over source temperature for single zone VAV units. The MicroTech IV controller can handle up to three space temperature sensor inputs and the min, max, average or a specific sensor can be used for control. Review “Unit Set-Up Menu” on page 21 for Space Temperature Control Configuration.
- **RAT:** Return is an ideal change over source temperature for single zone VAV units that do not have a space sensor available.
- **None and OAT** are not allowed.

## Space Set point Adjustment

When a unit is configured for space temperature control or single zone VAV and the control temperature source is set to Space; the user has the option of using a space mounted remote sensor with set point adjustment functionality to control the set point of the space being controlled. The MicroTech controller will allow one space sensor to drive the **Space Set point Adjustment** feature. Rem Spt Src allows the user to select which Network sensor (up to 3 sensors) will drive the set point adjustment or if an analog sensor will be driving the Space Set point Adjustment.



## Heat/Cool Changeover Menu

### HtgClg ChgOvr Set-Up

The **Heating Cooling Change Over Set-Up** menu is a commissioning menu that provides adjustable parameters to configure the method and conditions with which the unit state changes.

**Table 14: Main Menu \ Commission Unit \ HtgClg ChgOvr Set-Up**

Menu Display Name	Default	Range	Description
Ctrl Temp Src	RAT	RAT Space OAT None	Ctrl Temp Src is an adjustable item which selects the temperature sensor input to be used for the unit heating/cooling changeover or occupied cooling and heating capacity change decisions.
Rem Spt Src	None	None AI	Rem Spt Src is an adjustable item used to set whether or not to use the a remote space sensor to drive the set point adjustment value for the Occ Clg Spt and Occ Htg Spt. This can be designated to a single sensor.
Rem Spt Src	None	None QMX1 QMX2 QMX3	An adjustable item used for selecting the Remote Set point Source.
Control Temp	-	-461.2-525.2°F	Control Temp is a status only item which displays the current value of the "Control Temperature." The "Control Temperature" is defined as the temperature input selected by the Control Temperature Source parameter.
Occ Clg Spt	72.0°F	0.0-100.0°F	Occ Clg Spt is an adjustable item adjusts the temperature in which the unit will go into the cooling mode of operation. Once a valid password has been entered this item becomes an adjustable item.
Occ Htg Spt	68.0°F	0.0-100.0°F	Occ Htg Spt is an adjustable item which adjusts the temperature in which the unit will go into the heating mode of operation. Once a valid password has been entered this item becomes an adjustable item.
Occ Clg DB	2.0°F	0.0-10.0°F	Occ Clg DB is an adjustable item which sets a dead band around the Occ Cooling Set Point parameter. For example, if the Occ Cooling Set Point parameter is set to 75°F and the Clg Deadband parameter is set to 2°F the dead band around the set point would be from 76.0°F to 74.0°F.
Occ Htg DB	2.0°F	0.0-10.0°F	Occ Htg DB is an adjustable item which sets a dead band around the Occ Heating Set Point parameter. For example, if the Occ Heating Set Point parameter is set to 70°F and the Htg Deadband parameter is set to 2°F the dead band around the set point would be from 69.0°F to 71.0°F.
RmtSptLoLmt	40.0°F	40.0°F-100.0°F	RmtSptLoLmt is an adjustable item which sets the lower bound of the allowed range of set point adjustment from the remote space temperature sensor.
RmtSptHiLmt	100.0°F	40.0°F-100.0°F	RmtSptHiLmt is an adjustable item which sets the higher bound of the allowed range of set point adjustment from the remote space temperature sensor.
CalRemSpt@10°C	No	No Yes	CalRemSpt@10°C is an adjustable item used to calibrate the digital space sensor minimum set point input when the engineering units set to SI.
CalRemSpt@50°F	No	No Yes	CalRemSpt@30°C is an adjustable item used to calibrate the digital space sensor maximum set point input when the engineering units set to SI.
CalRemSpt@30°C	No	No Yes	CalRemSpt@50°F is an adjustable item used to calibrate the digital space sensor minimum set point input when the engineering units set to English.
CalRemSpt@86°F	No	No Yes	CalRemSpt@86°F is an adjustable item used to calibrate the digital space sensor maximum set point input when the engineering units set to English.
Demand Shed	Enable	Disable Enable	Demand Shed is an adjustable item used to enable or disable the ability of the a demand shed sequence to be initiated where the occClg or Occ Heat setpoints are overridden by predetermine shed increments.

## Supply Air Fan

### Supply Air Fan Operation

A supply air fan will be provided with every unit. The standard supply fans will be controlled using a factory EC motor for each fan. Each motor is controlled via a Modbus interface.

The supply fans will control between an adjustable minimum and maximum fan capacity. The range is adjustable from 0-100% with separate ranges for cooling and heating operation.

The supply fan is turned ON when the unit enters the Recirculation state. The supply fan is turned OFF when the unit transitions to the OFF state, but stays on for the Off HtCIDelayTime (Default=120s) if the unit is turned OFF while DX Cooling or heating is active. The OffHtCIDelay time function is overridden when an Emergency Off or Duct High Limit Fault is active.

- **Speed/Network Control(Spd/Net):** A speed/network fan control type controls the supply fan capacity to fixed speed value that is set at the unit controller or via a network input signal.
- **Single Zone VAV Control(1ZnVAV):** Single Zone VAV control operates the unit as a single VAV box. The cooling is controlled to maintain a discharge air temperature set point and the supply fan is modulated to maintain a space temperature set point, the occupied cooling and occupied heating set point.
- **Duct Pressure Control(DSP):** Duct pressure control operates the unit to maintain the supply duct conditions. The cooling is controlled to maintain a discharge air temperature set point and the supply fan is modulated to maintain a supply duct static pressure set point. The duct pressure set point can be adjusted at the unit controller interface or via a network input signal.
- **Carbon Dioxide Control(CO2):** When a unit is configured for 100% outdoor air application and the control type is discharge temperature control, the unit can be configured to control the supply fan capacity based on a CO2 sensor input. The supply fan capacity will vary linearly between a minimum and maximum CO2 SAF capacity based on a minimum and maximum CO2 input (PPM) from a field mounted sensor.
- **Supply Airflow Control (Flow):** When a unit is equipped with a supply fan airflow measuring station, the control type is discharge temperature control and the unit is configured to flow control, the supply air fan capacity is modulated to maintain an adjustable airflow(cfm) set point.
- **Building Static Pressure Control (BSP):** When a unit is configured for 100% outdoor air application and the control type is discharge temperature control, the supply fan control can be configured to modulate to maintain a supply fan building static pressure set point.

## Supply Fan Menu

The SAF Control Menu displays the fan operation and the relevant current control parameters.

**Table 15: Main Menu \ View Status \ SAF Control**

Menu Display Name	Default	Range	Description
SAF Capacity	-	0-100%	SAF Capacity is a status only item that indicates the current supply fan capacity.
SAF Cap Cmd	-	0-100%	SAF Cap Cmd is a status only item that indicates the current supply fan commanded capacity.
SAF DuctPress	-	0.0-5.0in	SAF Duct Press is a status only item which displays the current supply duct static pressure reading.
CO2 PPM	-	0-5000 ppm	CO2 PPM is a status only item which displays the current CO2 PPM reading.
OA Flow	-	0-60000CFM	OA Flow is a status only item which displays the current OA Flow reading.
SAF Flow	-	0-60000CFM	SAF Flow is a status only item which displays the current supply air fan airflow reading.
Bldg Press	-	-0.250-0.250in	Bldg Press is a status only item indicated the current building static pressure reading.

## Supply Fan Set-Up Menu

**Table 16: Main Menu \ View Status \ SAF Set-Up**

Menu Display Name	Default	Range	Description
SAF Ctrl	CAV	DSP Spd/Net 1ZnVAV BSP CO2 Flow CAV	SAFCtrl is an adjustable parameter used to select how the supply fan is to be controlled. The supply fan can normally be controlled by CAV, duct pressure(DSP), space temperature (1ZnVAV), or Speed/Net Control which allows a constant speed to be set or adjusted with a building automation system. In 100% Outside air applications the supply fan can be controlled with a PI_Loop to maintain a CO2 set point, a constant CFM set point (Flow), or Build static pressure set point (BSP).
SPEED CONTROL			
Rem SAF Cap	33%	0-100%	Rem SAF Cap is an adjustable item for setting the supply fan speed by the keypad or by a network control signal.
DSP CONTROL			
SAF DuctPress	-	0.0-5.0in	SAF Duct Press is a status only item that indicates the current value for the duct static pressure sensor.
SAF DSP Spt	1.0in	0.2-4.0in	SAF DuctSP Spt is an adjustable item which sets the supply fan duct static pressure set point. The SAF is modulated with a PI_Loop to maintain this set point.
SAF DSP DB	0.1in	0.0-0.5in	SAF DSP DB is an adjustable item which sets a dead band around the DuctSP Spt. No Duct static pressure control action is taken when the current duct static pressure input is within this deadband.
1 ZONEVAV CONTROL			
Control Temp	-	-461.2-525.2°F	Control Temp is a status only item which displays the current value of the "Control Temperature." The "Control Temperature" is defined as the temperature input selected by the Control Temperature Source parameter.
Occ Clg Spt	72.0°F	0.0-100.0°F	Occ Clg Spt is a status only item which indicates the temperature in which the unit will go into the cooling mode of operation. Once a valid password has been entered this item becomes an adjustable item.

Menu Display Name	Default	Range	Description
Occ Htg Spt	68.0°F	0.0-100.0°F	Occ Htg Spt is a status only item which indicates the temperature in which the unit will go into the heating mode of operation. Once a valid password has been entered this item becomes an adjustable item.
Occ Clg DB	2.0°F	0.0-10.0°F	Occ Clg DB is an adjustable item which sets a dead band around the Occ Cooling Set Point parameter. For example, if the Occ Cooling Set Point parameter is set to 75°F and the Clg Deadband parameter is set to 2°F the dead band around the set point would be from 76.0°F to 74.0°F.
Occ Htg DB	2.0°F	0.0-10.0°F	Occ Htg DB is an adjustable item which sets a dead band around the Occ Heating Set Point parameter. For example, if the Occ Heating Set Point parameter is set to 70°F and the Htg Deadband parameter is set to 2°F the dead band around the set point would be from 69.0°F to 71.0°F.
<b>CO2 CONTROL</b>			
CO2 PPM	-	0-5000ppm	CO2 PPM is a status only item which indicates the current reading from the CO2 sensor.
CO2SensorSrc	QMX1	QMX1 QMX2 QMX3	CO2SensorSrc is an adjustable item that sets the source sensor type for CO2 control.
Min SAF PPM	800	0-5000ppm	Min SAF PPM is an adjustable item that sets the PPM value at which the supply fan speed is controlled to minimum when CO2 supply fan control is selected.
Max SAF PPM	1100	0-5000ppm	Max SAF PPM is an adjustable item that sets the PPM value at which the supply fan speed is controlled to maximum when CO2 supply fan control is selected.
Min PPM Cap	50	0-100%	Min PPM Cap is an adjustable item that sets the supply fan capacity when the CO2 input signal is at minimum when CO2 supply fan control is selected.
Max PPM Cap	100	0-100%	Max PPM Cap is an adjustable item that sets the supply fan capacity when the CO2 input signal is at maximum when CO2 supply fan control is selected.
<b>FLOW CONTROL</b>			
OA Flow	-	0-60000CFM	OA Flow is a status only item that displays the current outdoor air flow CFM.
OA Flow Spt	2000CFM	0-60000CFM	OA Flow Spt is an adjustable item that sets the Outdoor airflow cfm that the PI_loop will modulating the SAF capacity to maintain.
OAFLOW DB	3%	0-100%	OAFLOW DB is an adjustable item that sets a deadband around the OA Flow Set point.
SAF Flow	-	0-60000CFM	SAF Flow is a status only item that displays the current supply air fan airflow CFM.
SAF Flow Spt	2000CFM	0-60000CFM	SAF Flow Spt is an adjustable item that sets the SAF Flow CFM set point that the PI_Loop will modulate the supply air fan capacity to maintain.
SAF Flow DB	3%	0-100%	SAF Flow DB is an adjustable item that set a deadband around the SAF Flow Set point.
<b>BSP CONTROL</b>			
Bldg Press	-	-0.250-0.250in	Bldg Press is a status only item indicated the current building static pressure reading.
Bldg SP Spt	0.050in	-0.250-0.250in	BldgSP Spt is an adjustable item which sets the current building static pressure set point.
BSP DB	0.010in	0.000-0.100in	BSP DB is an adjustable item that sets the deadband around the Bldg SP set point that the PI Loop will modulating the Supply air fan capacity to maintain.
<b>SAF SETUP</b>			
MaxSAF Hz	60Hz	0-100Hz	MaxSAF Hz is an adjustable item that sets the maximum supply air fan speed (Hz) that will be allowed in units using the analog VFD output.

Menu Display Name	Default	Range	Description
MaxSAF RPM	2600RPM	0-2600RPM	MaxSAF RPM is an adjustable item that sets the maximum supply air fan speed (RPM) that the supply air fans will be allowed to operate at in units that are us the ECM supply fans. Note this is set based on the supply fan model size and the system specifications.
Min Clg Spd	33%	0-100%	MinClgSpd is an adjustable item that sets the minimum supply fan speed used for cooling operation.
Max Clg Spd	100%	0-100%	MaxClgSpd is an adjustable item that sets the maximum supply fan speed used for cooling operation.
Min Htg Spd	33%	0-100%	MinHtgSpd is an adjustable item that sets the minimum supply fan speed used for heating operation.
Max Htg Spd	100%	0-100%	MaxHtgSpd is an adjustable item that sets the maximum supply fan speed used for heating operation.
VAVBox Out	-	Heat Cool	VAVBox Out is a status only item that indicates the current value of the VAV output. The VAV output is only available to the field via network communications.
SAF1 Status	-	Fault OK	A status only item which indicates the current state of Supply Fan 1.
SAF1Status	-	OK HLL TFEI TFM TFE BLK SKF PHA UzLow UzHigh UeLow UeHigh NoComm	SAF1Status is a status only option that indicates the fault status with SAF operation for the ECM fan. HLL=Hall Sensor Error TFEI= Electronics Interior Overheated TFM=Motor Overheated TFE=Power Mod Overheated BLK=Locked Motor SKF=Communication Error PHA=Phase Failure UzLow=DC-Link Undervoltage UzHigh=DC Link Overvoltage UeHigh=Mains Overvoltage UeLow=Mains Undervoltage

## Exhaust Fan

Rooftop units may be equipped with zero, one, or more **Exhaust Fans**. Normally, each exhaust fan will be controlled with an ECM Motor per fan via a Modbus interface. An option for controlling a single VFD connected to one or more exhaust fan motors will also be provided. In this case, the VFD will be controlled via modbus signal from the unit controller. The exhaust fan capacity of the fan will be controlled between an adjustable minimum and maximum fan capacity.

## Exhaust Fan Operation

### Exhaust Fan

When a unit is equipped with an **Exhaust Fan**, the exhaust fan On/Off command logic will depend on the selected exhaust fan control method.

## Exhaust Fan Control Types

### Constant Volume Control (CAV)

When the EF Ctrl is set to **CAV**, the exhaust fans will be controlled to the MaxEF Capacity.

### Building Static Pressure Control (BSP)

When the EF Ctrl is set to **BSP** the exhaust fan's capacity will be modulated to maintain the building static pressure at the building static pressure set point (BldgSPSpt).

## Fan Tracking Control (Tracking)

When the EF Ctrl is set to **Tracking** the or exhaust fan capacity is varied to maintain an adjustable offset between the Exhaust Fan capacity and the Supply Fan Capacity. The user specifies the offset at maximum supply fan capacity and the offset at minimum supply fan capacity and the EF controls linearly between the two points.

Figure 23: Exhaust Fan Tracking

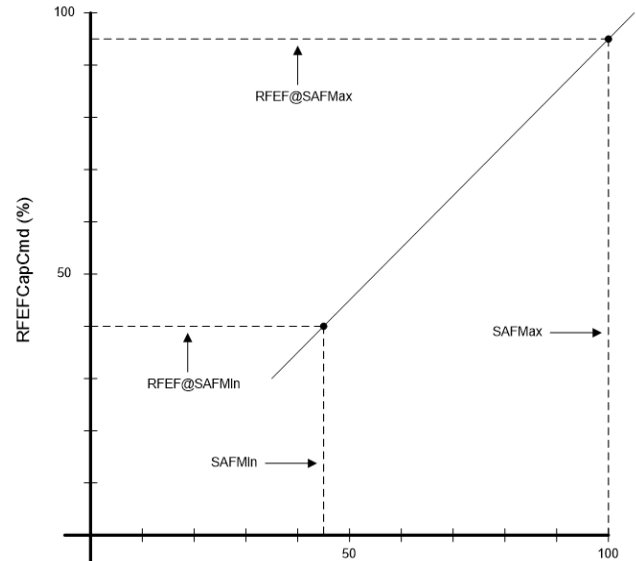

The field process for setting these parameters will be as follows:

1. With the unit running and the outdoor air dampers at minimum position (in Fan Only State for example), the VAV box system will be manipulated to simulate a call for maximum airflow.
2. The Supply air fan will be allowed to stabilize (normally under DSP control) and the SAFMax parameter will be set to the steady-state SAF Capacity value.
3. The EF@SAFMax value will then be adjusted until the desired building pressure is obtained (usually slightly positive).
4. The VAV Box system will then be manipulated to simulate call for minimum airflow.
5. The supply air fan will be allowed to stabilize (normally under DSP control) and the SAFMin Parameter will be set to the steady-state SAF Capacity value.
6. The EF@SAFMin Value will be adjusted until the desired building pressure is obtained (generally slightly positive).

**NOTE:** Ideally the minimum and maximum conditions should be checked with the outdoor dampers at minimum and maximum positions to assure there are not significantly different requirements depending on the outdoor damper position. If the differences are significant then the parameters may be manually adjusted to compromise between the two conditions. If the differences are too great, it may be necessary

to change to building pressure EAF control for the application.

**NOTE:** Setting the minimum and maximum tracking points will not necessarily establish minimum and maximum SAF modulation ranges, but rather simply establishes the slope of the tracking curve. The curve line will be projected up to effective max SAF capacity and down to the effective minimum SAF capacity.

## Speed/Network Control(Spd/Net)

When the EF Ctrl is set to **Spd/Net** the fan capacity is set to the remote exhaust fan capacity parameter value (RemEFCap). These values may be set via the HMI or a network input signal.

## Airflow Control(Flow)

When a unit is equipped with a exhaust airflow measuring station and the EF Ctrl is set to **Flow**, the Exhaust fan capacity will be modulated to maintain the airflow at the airflow set point.

## Flow Differential Control (FlowDiff)

When the unit is equipped with a supply airflow measuring station and a exhaust fan airflow measuring station and the EF Ctrl is set to **Flow Diff**, the Exhaust fan capacity will be modulated to maintain an adjustable flow differential between exhaust fan flow and the supply fan flow. The flow differential set point will vary linearly between an adjustable maximum differential (MaxFlwDiff) when the supply air fan airflow is at a maximum flow (SAFHiFlow) to a minimum differential(MinFlwDiff) when the supply fan airflow is at minimum flow (SAFLoFlow).

## Outdoor Air Damper Control (OAD)

When the unit is equipped with an exhaust fan and the EF Ctrl is set to **OAD** the exhaust fan capacity will be varied based on the current outdoor air damper position. The exhaust fan capacity will vary linearly between the minimum exhaust fan capacity (MinEF Cap) and the maximum (MaxEFCap) as the OA damper varies between the exhaust on outdoor air damper position (ExhOnOA Pos) and the exhaust maximum outdoor air position (ExhMxOAPos).

## Passive Ventilation Sequence

An optional **Passive Ventilation Sequence** will be performed when the passive ventilation digital input on the control is closed (on) Or when the Network passive ventilation input is set to On. When passive ventilation is active several actions occur.

- Unit state is switched to OFF
- The Supply Fan is switched of OFF
- The Exhaust Fan is Held on and set to the exhaust air fan ventilation capacity
- The OA Damper is set to 0%

## Exhaust Fan Menus

### EF Control Menu

The EF Control Menu is a view status menu that displays all relevant exhaust fan control parameters.

**Table 17: Main Menu \ View Status \ EF Control**

Menu Display Name	Default	Range	Description
EF Capacity	-	0-100%	EF Capacity is a status only item that indicates the current exhaust fan capacity.
EF Cap Cmd	-	0-100%	EF Cap Cmd is a status only item that indicates the current exhaust fan commanded capacity.
Bldg Press	-	-0.250-0.250in	Bldg Press is a status only item indicated the current building static pressure reading.
EF Flow	-	0-60000CFM	EF Flow is a status only item which displays the current exhaust air fan airflow reading.

### EF Set-Up Menu

The EF Set-Up menu is a commissioning menu that provides access to adjustable parameters to set the exhaust fan operating controls.

**Table 18: Main Menu \ Commission Unit \ EF Set-Up**

Menu Display Name	Default	Range	Description
EF Ctrl	BSP	CAV BSP Tracking DSP Spd/Net Flow OAD FlowDiff	EF Ctrl is an adjustable parameter used to select how the exhaust fans are to be controlled. The exhaust fans can be controlled by the building static pressure (BSP), A fixed Speed that can be adjusted through a building automation system (Spd/Net), a CFM set point (Flow), and Outdoor air damper position (OAD) where the exhaust fan speed changes with the OA damper position. In 100% Outside air application with exhaust fans, tracking of the supply fan can be used.
SPEED CONTROL			
Rem EF Cap	5%	0-100%	Rem EF Cap is an adjustable item for setting the exhaust fan capacity by the keypad or by a network control signal.
BSP CONTROL			
Bldg Press	-	-0.250-0.250in	Bldg Press is a status only item indicated the current building static pressure reading.
Bldg SP Spt	0.050in	-0.250-0.250in	BldgSP Spt is an adjustable item which sets the current building static pressure set point.
BSP DB	0.010in	0.000-0.100in	BSP DB is an adjustable item that sets the deadband around the Bldg SP set point that the PI Loop will modulating the exhaust air fan capacity to maintain.
FAN TRACKING CONTROL			
Sup Fan Max	100%	0-100%	Sup Fan Max is an adjustable item used to set the supply fan maximum capacity when the EF control method is set to tracking.
Sup Fan Min	30%	0-100%	Sup Fan Min is an adjustable item used to set the supply fan minimum capacity when the EF control method is set to tracking.
FLOW CONTROL			
EF Flow	-	0-60000CFM	EF Flow is a status only item that displays the current exhaust air fan airflow CFM.
EF Flow Spt	2000CFM	0-60000CFM	EF Flow Spt is an adjustable item that sets the EF Flow CFM set point that the PI_Loop will modulate the exhaust air fan capacity to maintain.



Menu Display Name	Default	Range	Description
EF Flow DB	3%	0-100%	EF Flow DB is an adjustable item that set a deadband around the EF Flow Set point. No action is taken when the current EF Flow input is within this deadband.
FLOW DIFF CONTROL			
SAF Flow	-	0-60000CFM	SAF Flow is a status only item that displays the current supply air fan airflow CFM.
EF Flow	-	0-60000CFM	EF Flow is a status only item that displays the current exhaust air fan airflow CFM.
OAD POSITION CONTROL			
ExhOn OA Pos	40%	0-100%	ExhOn OA Pos is an adjustable item that sets the damper position that the exhaust fan turns on at minimum capacity. Less than this position, the exhaust fan is off.
ExhMx OA Pos	100%	0-100%	ExhMx OA Pos is an adjustable item that sets the damper position that the exhaust fan is operating at maximum capacity.
EF SETUP			
MaxEF Hz	60Hz	0-100Hz	Max RF/EF Hz is an adjustable item that sets the maximum exhaust fan value. The maximum value settings must also be changed in the VFDs to match this setting. This is only for units with VFDs.
MaxEF RPM	2600RPM	0-2600RPM	MaxEF RPM is an adjustable item that sets the maximum exhaust air fan speed (RPM) that the exhaust air fans will be allowed to operate at in units that are us the ECM fans. Note, this is set based on the Exhaust fan model size and the system specifications.
Min EF Cap	5%	0-100%	MinEF Cap is an adjustable item used to set the minimum capacity that the Exhaust fans will be allowed to operate at.
Max EF Cap	100%	0-100%	MaxEF Cap is an adjustable item used to set the maximum capacity that the Exhaust fans will be allowed to operate at.
EF1 Status=	-	Fault OK	A status only item which indicates the current state of Exhaust Fan 1.
EF2 Status=	-	Fault OK	A status only item which indicates the current state of Exhaust Fan 2.
EF3 Status=	-	Fault OK	A status only item which indicates the current state of Exhaust Fan 3.
EF Status	-	Fault OK No Comm	EF Status is a status only item that indicates if there are any Faults with the EF operation for units using the VFD analog output control.
EF1Status - EF6Status	-	OK HLL TFEI TFM TFE BLK SKF PHA UzLow UzHigh UeLow UeHigh NoComm	EF1Status - EF4Status is a status only option that indicates the fault status with EF operation for each ECM fan. HLL=Hall Sensor Error TFEI= Electronics Interior Overheated TFM=Motor Overheated TFE=Power Mod Overheated BLK=Locked Motor SKF=Communication Error PHA=Phase Failure UzLow=DC-Link Undervoltage UzHigh=DC Link Overvoltage UeLow=Mains Undervoltage UeHigh=Mains Overvoltage UeLow=Mains Undervoltage

# Cooling

## Zone Temperature Control

### Staged Compressors

In units equipped with staged compressors that are configured for **Zone Temperature Control**, the compressors stage on and off to maintain the control temperature (Space or RAT). The control temperature being maintained is the occupied or unoccupied cooling set point.

When a unit first enters the cooling state, the unit goes directly to Cooling Stage #1 so that the first compressor is turned On immediately. During normal cooling operation, the number of compressor stages increases when the time since last stage exceeds the Cooling Stage Timer (Default=5 min) and the projected control temperature is greater than the occupied or unoccupied cooling set point by more than half of the cooling deadband. Compressor stages decrease when the time since the last stage exceeds the cooling stage timer and the projected control temperature is less than the occupied or unoccupied cooling set point by more than half of the cooling deadband.

During normal cooling operation, the compressor stages may also decrease when the time since the last stage exceeds the cooling stage timer and the discharge air temperature is less than the minimum DAT cooling set point.

### Variable Speed Compressors

In units equipped with **Variable Speed Compressors** that are configured for Zone Temperature control, the compressor capacity will modulate to maintain the control temperature (Space or RAT). The control temperature being maintained is the occupied or unoccupied cooling set point. Compressor capacity will increase or decrease if the current reading of the control temperature is above, or below, the occupied or unoccupied cooling temperature set point by more than half of the cooling deadband.

## Discharge Air Temperature Control

### Staged Compressors

In units equipped with **Staged Compressors** that are configured for discharge air temperature control or 1ZnVAV operation, the compressors are staged on and off to maintain a cooling discharge air temperature set point. A time average control method is used to stage compressors up and down to provide smooth, average temperature control around the cooling discharge air temperature set point.

### Variable Speed Compressors

In units equipped with **Variable Speed Compressors** that are configured for discharge air temperature control or single zone VAV, the compressor capacity is modulated to maintain the cooling discharge air temperature set point. Compressor capacity is increased if the projected discharge air temperature reading

is greater than the cooling discharge air temperature set point by more than  $\frac{1}{2}$  the cooling DAT deadband. Conversely, the compressor capacity is decreased if the projected discharge air temperature reading is less than the cooling discharge air temperature set point by more than  $\frac{1}{2}$  the cooling DAT deadband.

## Cooling DAT Reset

The **Cooling DAT Set point** may be reset for units with DAT Cooling Control. The reset type may be set to one of the following:

- **None:** Discharge Cooling Spt is user adjustable
- **Network:** Discharge Cooling Spt is equal to the Network DAT Clg Set point when it is valid
- **Space:** Discharge Cooling Spt is based on the Space Sensor
- **Return:** Discharge Cooling Spt is based on the Return Air Sensor
- **OAT:** Discharge Cooling Spt is based on the Outdoor Air Temperature
- **Ext mA:** Discharge Cooling Spt is determined by a 0-20 mA signal
- **Ext V:** Discharge Cooling Spt is determined by a 0-10 VDC signal
- **Airflow:** Discharge Cooling Spt is based on the airflow as indicated by the variable frequency drive speed
- **SpaceH1:** Discharge Cooling Spt is based on the humidity based on humidity sensor 1.
- **SpaceH2:** Discharge Cooling Spt is based on the humidity based on humidity sensor 2.
- **SpcDwpt1:** Discharge Cooling Spt is based on the calculated dew point based on dew point sensor 1
- **SpcDwpt2:** Discharge Cooling Spt is based on the calculated dew point based on dew point sensor 2
- **OADwpt:** Discharge Cooling Spt is based on the calculated Outdoor Air Dew point
- **RADwpt:** Discharge Cooling Spt is based on the calculated Return Air Dew point

Reset reverts from Return to None when a Return Air Sensor opens or Shorts. Reset Reverts from Space to None when a Space Sensor opens or shorts. Reset Reverts from OAT to None when an Outdoor Air Sensor opens or shorts.

When Space, Return, OAT, Airflow, SpaceH1, SpaceH2, SpcDwpt1, SpcDwpt2, OADwpt, RADwpt, Ext mA or ExtV is selected, the Discharge Cooling Spt equals the Max Clg Spt when the selected value equals the Max Clg Spt @ value. Similarly, the Discharge Cooling Spt equals the Min Clg Spt when the selected value equals the Min Clg Spt @ Value.

When the Space, Return, OAT, SpaceH1, SpaceH2, SpcDwpt1, SpcDwpt2, OADwpt, RADwpt, or Airflow is selected, the reset schedule should be set so that the DAT Cooling Set point decreases as the selected temperature increases as shown in the graph.

**Figure 24: Cooling DAT Setpoints**

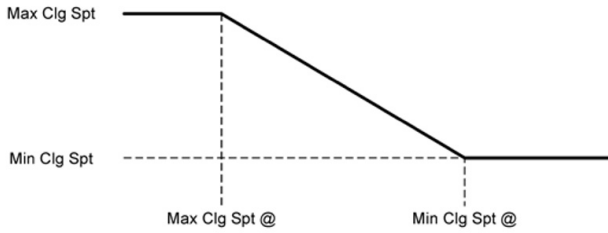

When Airflow, Hum1, or Hum2 is selected, the values “Min Clg Spt@” and “Max Clg Spt @” are entered as percentage values. When ExtmA is Selected, the values “Min Clg Spt@” and “Max Cl Spt @” are entered as mA values. When Ext VDC is selected, the values “Min Clg Spt@” and “Max Cl Spt @” are entered as VDC values.

If Ext mA or Ext V is selected as the type of reset, the Min Clg Spt@ value may be set above the Max Clg Spt@ value to cause a decrease in the DAT set point as the external signal or the Min Clg Spt @ value may be set below the Max Clg @ Spt Value to cause an increase in the DAT set point as the external set point increases.

The Min Clg Spt@ value can be set below the Max Clg Spt @ Value for all types of reset, but it only makes sense for external reset.

**Cooling DAT Reset Application Considerations**

These examples are just some common uses of DAT reset, other building/application factors may require different values or schedule sources.

**Table 19: Cooling DAT Reset**

	1		2		3	
	OAT	Clg DAT	Airflow	Clg DAT	ExtSig	Clg DAT
Min	45F	60F	40%	65F	0V	65F
Max	65F	55F	60%	55F	10V	50F

1. **OAT:** OAT is an effective reset control strategy if all the zones served have similar loads and are mostly dependent on outdoor air temperatures. Examples would be west facing perimeter zones with the same lighting/equipment/occupancy loads. This reset strategy is problematic if zones require cooling regardless of outdoor air temperature. This could be due to internal gains or general interior spaces of large buildings.
2. **Airflow:** This is an effective reset control strategy for single zone or multizone VAV units because airflow is a close indicator of cooling demand. If a typical VAV unit supply fan speed range is 40-100% a good airflow capacity to being to reset the DAT is roughly 60-65%. By the time the fan speed is down to 50% the DAT can be reset to a warmer temperature.
3. **Network, ExtSig:** It is recommended that a network control the DAT reset schedule when a rooftop unit is applied in a multizone VAV system with diverse loads. In this case, the network can combine a building specific reset sequence based on the polling of VAV boxes and synchronizing the reset with a duct static pressure reset that maximizes energy efficiency.

## Cooling Menus

### Compressor Status

The Cooling Menu is a view status menu that displays all relevant Cooling Status items.

**Table 20: Main Menu \ View Status \ Compressor Status**

Menu Display Name	Default	Range	Description
Clg Capacity	-	0-100%	Clg Capacity is a status only item which indicates the percentage of the unit maximum cooling capacity currently operating.
Clg Status	-	Enabled None OffAmb OffAlm OffNet OffMan CfgErr	Clg Status is a status only item which indicates whether or not mechanical cooling is currently allowed. If cooling is disabled, the reason is indicated.
REFRIG CIRCUIT 1			
VCmp1	-	On Off	Vcmp1 is a status only item which indicates whether or not the variable compressor on circuit #1 is on or off.
C1FCmp1	-	On Off	A status only item which indicates the current state of Circuit 1 Fixed Compressor 1.
PTS1	-	0-725.2psi	A status only item which indicates the Suction Pressure in Refrigerant Circuit 1.
PTD1	-	0-725.29psi	A status only item which indicates the Discharge Pressure in Refrigerant Circuit 1.
SSH1	-	-100.0-100.0°F	A status only item which indicates the Suction Super Heat in Refrigerant Circuit 1.
DSH1	-	-100.0-100.0°F	A status only item which indicates the Discharge Super Heat in Refrigerant Circuit 1.
Subcooling1	-	-100.0-100.0°F	A status only item which indicates the Liquid Sub Cooling in Refrigerant Circuit 1.
Te1	-	-50.0-212.0°F	A status only item which indicates the Sat. Evap. Temperature in Refrigerant Circuit 1.
Tc1	-	-50.0-212.0°F	A status only item which indicates the Sat. Cond. Temperature in Refrigerant Circuit 1.
C1DRT1	-	-50.0-392.0°F	A status only item which indicates the Discharge Temperature of Comp. 1 in Refrigerant Circuit 1.
C1DRT3	-	-83.2-392.0°F	A status only item which indicates the Discharge Temperature of Comp. 3 in Refrigerant Circuit 1.
SRT1	-	-50.0-392.0°F	A status only item which indicates the Saturated Suction Temperature of Refrigerant Circuit 1.

## Cooling Setup

The Cooling Setup Menu is a view status menu that displays all relevant cooling status items.

**Table 21: Main Menu \ View Status \ Cooling Set-Up**

Menu Display Name	Default	Range	Description
Circ1 CmpState	-	Off Start Init1 Init2 Init3 Normal Pmpdn1 Pmpdn2 Pmpdn3 Standby	Circ1 CmpStat is a status only item that displays the current state/activity for each cooling circuit.
Circ1Status	-	Enabled Disabled	Circ1Status is a status only item that displays if the refrigeration circuit is enabled or disabled for cooling operation.
VCmp1 Cap	-	0-110%	A status only item which indicates the current Capacity of Variable Compressor 1.
VCmp1 Cmd	-	0-100%	A status only item which indicates the current Commanded speed of Variable Compressor 1.
VCmp1 Rps	-	0-150	A status only item which indicates the current speed (RPS) of Variable Compressor 1.
C1FCmp1	-	Off On	A status only item which indicates the status (on/off) of Circuit 1/ Fixed Compressor 1.
Control Temp	-	-461.2- 525.2.0°F	Control Temp is a status only item which displays the current value of the "Control Temperature." The "Control Temperature" is defined as the temperature input selected by the Control Temperature Source parameter. For example, if the Control Temperature Source parameter is set to "Return," then the control temperature parameter reads the same value as the Return Air parameter.
Occ Clg Spt	72.0°F	0.0-100.0°F	Occ Clg Spt is an adjustable item which indicates the temperature in which the unit will go into the cooling mode of operation.
Occ Clg DB	2.0°F	0.0-10.0°F	Occ Clg DB is an adjustable item which sets a dead band around the Occ Cooling Set Point parameter. For example, if the Occ Cooling Set Point parameter is set to 75°F and the Clg Deadband parameter is set to 2°F the dead band around the set point would be from 76.0°F to 74.0°F.
Disch Air	-	-50.0-250.0°F	Disch Air is a status only item which displays the current temperature reading from the unit's discharge air temperature sensor (DAT). This sensor is standard on all units.
DAT ClgSpt	55.0°F	40.0-100.0°F	DAT Clg Spt is an adjustable item which sets the temperature that the DAT should be maintained at when it is in the cooling mode of operation. This value is adjustable on DAC and 1ZnVAV units. It is not adjustable on CAV units.
DAT Clg DB	2.0°F	1.0-10.0°F	DAT Clg DB is an adjustable item which sets the deadband around the DAT Clg Spt. If the disch air is within the DB no action is take. For example, if the discharge cooling set point is set to 55°F and the Clg DB is set to 2°F the dead band around the set point would be from 56.0°F to 54.0°F.
Eff Space T	-	0.0-150.0°F	Eff Space T is a status only item that displays the current effective space temperature.
Unocc Clg Spt	85.0°F	40.0-100.0°F	Unocc Clg Spt is an adjustable item which sets the zone temperature above which the unit starts up and provides unoccupied cooling (night setup) during unoccupied periods. Note: setting this to its maximum value will disable unocc cooling.

Menu Display Name	Default	Range	Description
Unocc Diff	3.0°F	0-10.0°F	Unocc Diff is an adjustable item which sets a differential above and below the Ucc Clg Spt. Mechanical Cooling operation is enabled when the Control temp is above the Unocc Clg spt by the unocc diff. Conversely, mechanical cooling operation is disabled when the control temp is below the Unocc Clg Spt by the Unocc Diff.
Clg Stg Time	5 min	5-60min	Clg Stage Time is an adjustable item used to set a minimum time period between compressor stage changes.
OA Temp	-	-50.0-200.0°F	OA Temp is a status only item which displays the current temperature reading from the unit mounted Outdoor air temperature sensor. This sensor is standard on all units.
Clg Lo OAT Lk	25°F	-20.0-100°F	Clg Lo OAT Lk is an adjustable item which sets the low outdoor air temperature mechanical cooling lockout point. Mechanical cooling operation is disabled when the outdoor air temperature sensor input falls below this set point.
OAT Diff	2.0°F	0-10.0°F	OATDiff is an adjustable item which sets a differential above the OAT Clg Lock parameter. Mechanical cooling operation is re-enabled when the outdoor air temperature sensor input rises above the OAT Clg Lock value by more than this differential.
Clg Reset	None	None Network Space Return OAT ExtmA ExtV Airflow SpaceH1 SpaceH2 OAH RAH SpcDpt1 SpcDpt2 OADwpt RADwpt	Clg Reset is an adjustable item that is used to set the type of cooling reset to be used.  Notes: Space (Not selectable when SpaceTCfgis none) ExtmA (Not selectable when RemSptSrc is Yes) ExtV (Not Selectable when RemSptSrc is Yes)
Min Clg Spt	55.0°F	40.0-100.0°F	Min Clg Spt is an adjustable item which sets the minimum cooling discharge set point for use with a cooling discharge air temperature set point reset schedule.
Min Clg Spt@	0	0-100/ NA °F °C mA V %	Min Clg Spt @ is an adjustable item which sets the value of the sensor input, selected with the Cooling Reset parameter, at which the DAT cooling set point parameter is reset to the minimum DAT cooling set point value.
Max Clg Spt	65.0°F	40.0-100.0°F	Max Clg Spt is an adjustable item which sets the maximum cooling discharge set point for use with a cooling discharge air temperature set point reset schedule.

Menu Display Name	Default	Range	Description
Max Clg Spt@	100	0-100/ NA °F °C mA V %	Max Clg Spt @ is an adjustable item which sets the value of the sensor input, selected with the Cooling Reset parameter, at which the DAT cooling set point parameter is reset to the maximum DAT cooling set point value.

## Dehumidification

**Dehumidification** is an operating mode that is only allowed when the unit is in either the Fan Only or Cooling States. When dehumidification is active, the unit is not allowed to operate in the Economizer or MinDAT states. Normal temperature control is overridden and mechanical cooling will instead be used to lower the air temperature enough to wring out moisture and subsequently, reheat will be used to raise it back up to achieve the unit discharge air temperature requirements. Reheat types can be Hot Gas Reheat or the standard heating equipment (Gas or Steam/Hot Water).

### Dehumidification Initiation

Dehumidification operation is available in both the Cooling and Fan Only unit states, and is initiated by one or two analog or network humidity sensors that are mounted in the return duct, space, or outdoors to sense relative humidity. The unit may be set up to dehumidify based on relative humidity, dew point, or continuously. Each humidity sensor can have a separate set point, Hum1, Hum2, or Dwpt1 and Dwpt2. Humidity sensors are configured in the Humidity Sensor Set-Up Menu and the setpoints are configured in the Dehumidification Set-Up menu.

- **Relative Humidity or Dew point:** When configured for relative humidity or dew point, the basis of dehumidification will be determined by one or two relative humidity sensors.
- **Always:** When configured to dehumidify continuously, dehumidification and reheat will operate regardless of relative humidity or dew point, and will operate any time the unit is in the Cooling or Fan Only unit states.
- **Unoccupied:** Dehumidification default settings allow dehum to operate in occupied only, The unoccupied operation is an adjustable setting to allow unoccupied dehumidification.

## Dehumidification Operation

The left psychrometric chart below shows typical cooling operation. The space is 74°F and 50% and the rooftop unit is in mechanical cooling, providing 55°F air leaving the unit. If the space humidity rises above its 50% RH set point, Dehumidification is activated.

The right psychrometric chart shows cooling operation in dehumidification. In dehumidification operation, the unit is cooling the air temperature lower to provide a lower dew point supply air and latent dehumidification.

In the example below, the air cooled to provide 50°F dew point and is reheated to the DAT Cooling set point of 55°F to continue providing the same sensible cooling load. With this example in mind, the MicroTech has several methods for initiating dehumidification, and several variations of temperature and reheat control parameters that modify and enhance dehumidification performance.



Figure 25: Cooling/Dehumidification Psychrometric Charts

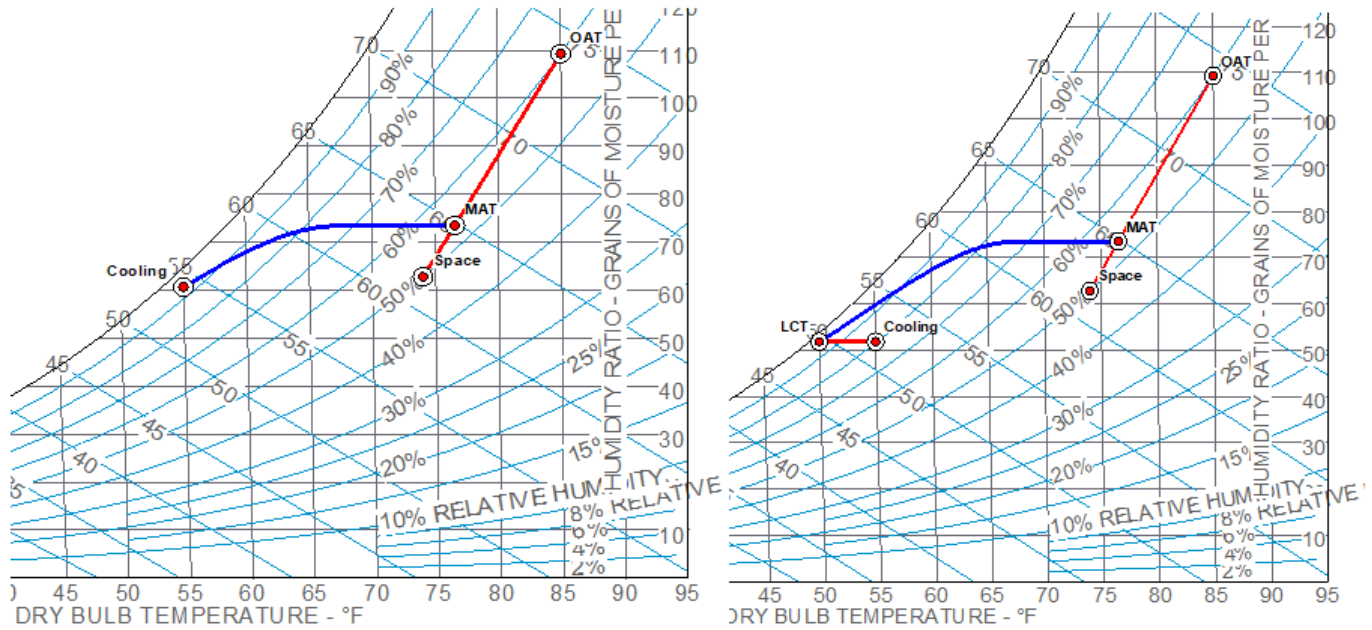

## Variable Speed Compressor

When dehumidification is active, **Variable Speed Compressor** capacity is modulated to maintain the leaving coil temperature within the deadband near the leaving coil temperature set point.

## Reheat Control

The reheat process is a critical component of the dehumidification process. All MicroTech controlled rooftops use a fully modulating reheat control to provide precise discharge temperature control during dehumidification. There are several forms of reheat that can be used. Reheat types can be Hot Gas Reheat or the standard heating equipment (Gas or Steam/Hot Water).

- **Cooling:** In the cooling state, the modulating hot gas and standard heat reheat will be controlled to the DAT Cooling. For DAT controlled units this is the normal DAT Cooling set point resulting from any reset. For Zone Control units, this set point is the result of a calculation based on the control temperature.
- **Fan Only:** In the fan only, state, the modulating hot gas and standard heat reheat will be controlled to the reheat set point. The reheat set point equals an editable MaxReheatSpt (Default = 65°F) when the control temperature drops to the Occupied or Unoccupied Heating Set point, and equals an editable MinReheatSpt (Default = 55°F) when the control temperature rises to the Occupied or Unoccupied Cooling set point. The Dehumidification Reheat Set point varies linearly between these two points. Users can choose to set these to be the same value (Example = 65°F) if they desire neutral air when there is no sensible cooling load.

Figure 26: Reheat Control

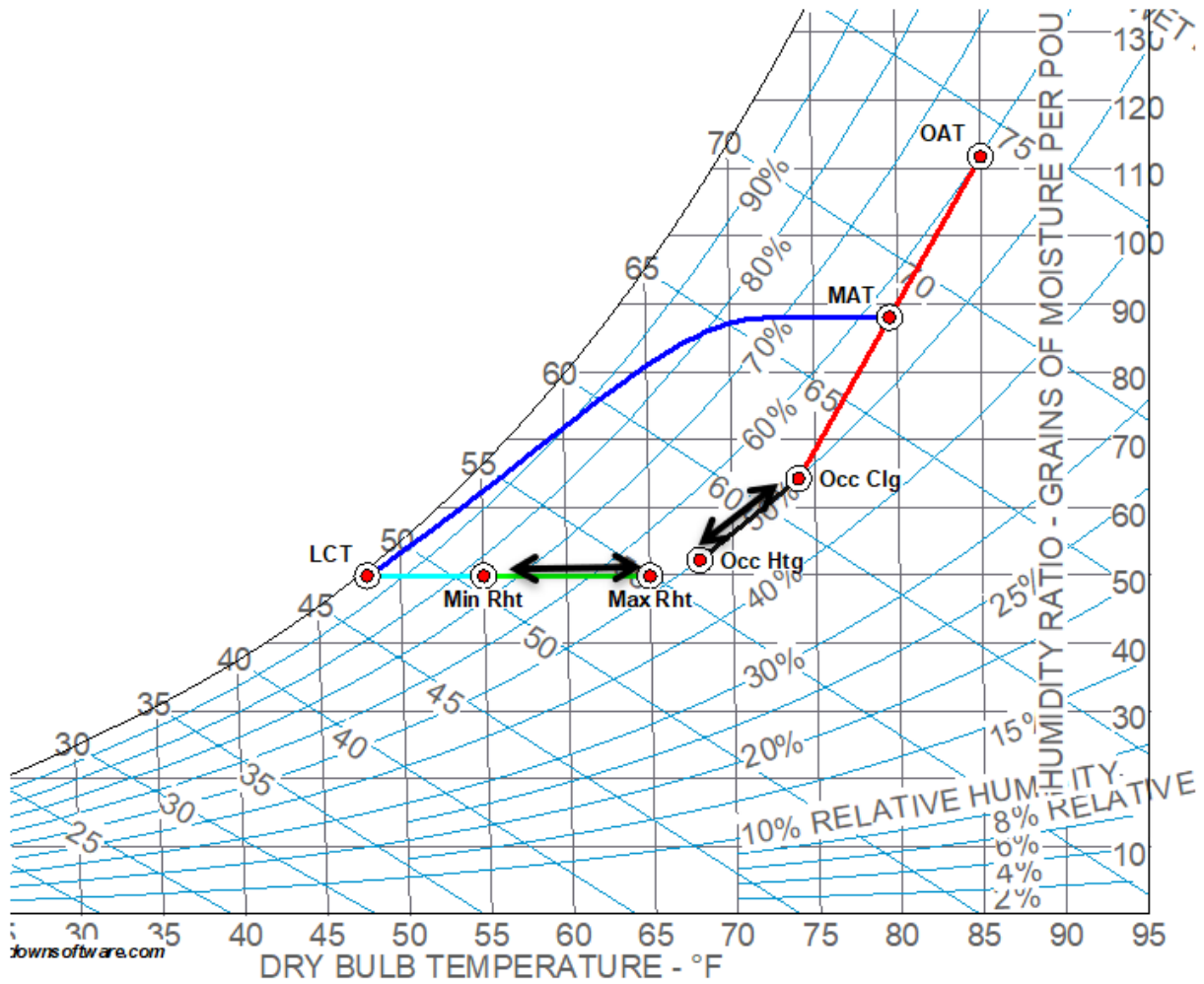
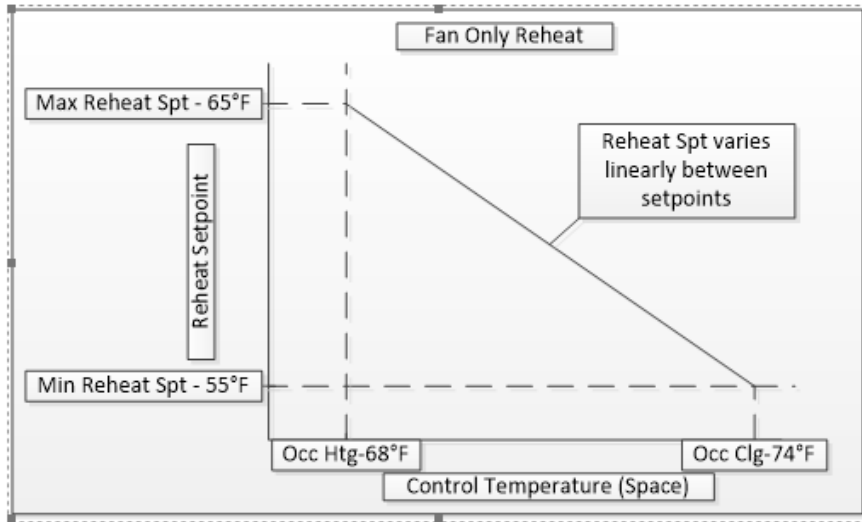

## LCT (Leaving Coil Temperature) Reset

Using a **Leaving Coil Temperature Reset** can be useful in humidity control applications where dehumidification loads vary greatly with occupancy or climate. By implementing a reset of the leaving coil temperature based on feedback from load driving variables, dehumidification control is enhanced by reacting to changing dehumidification loads throughout operation.

**Table 22: Recommended LCT Reset Schedules**

	1		2		3		Outdoor RH	LCT
	Space/RAT	LCT	Space RH/Dwpt	LCT	Airflow	LCT		
Min	74°F	50°F	50%	52°F	100%	52°F	70%	52°F
Max	70°F	45°F	60%	45°F	30%	45°F	100%	45°F

- 1. Space/RAT:** Space Air Temperature is a good reset temperature source for LCT when the primary dehumidification fluctuations happen during periods of little or no cooling load and the unit is most likely to be in the Fan Only state. If we consider a space with occupied cooling and heating setpoints of 74°F and 70°F respectively, at 74°F and 50% the dew point is 54.2°F and at 70°F and 50% RH the dew point is 50.5°F. As the space/unit operates in fan only and the temperature drops the dew point required to maintain 50% RH also drops. If a unit is likely to require dehumidification operation during fan only, this will require the LCT set point to drop as the space temperature drops in order to maintain a 50%RH space set point. Maintaining a constant LCT during fan only could result in a space humidity to increase by as much as 10%.
- 2. Space RH or Dew point:** Space Relative Humidity or DewPoint is a good source for LCT reset source when the dehumidification operation is likely to occur in both cooling and fan only operation. As the space humidity rises above the 50% RH or 55°F Dew point set point the LCT should be reduced proportional to the increase in RH or dew point so that any extra moisture in the space can be removed effectively.
- 3. Airflow:** Airflow is a good LCT reset source for most modulating supply fan applications. As fan speed slows proportionally with load, to provide the same moisture removal to the space (#/hr) a lower supply dew point is required. As an example, a 10,000 CFM air handler that delivers 52°F dew point air in dehumidification to a 74°F/50% space is removing 35.6 lbs/hr. At 50% airflow, that same air handler needs to supply 49°F dew point air to provide the same amount of dehumidification. Note: this reset type may be less effective in duct pressure VAV systems that have significant duct static pressure resets schedules being used.
- 4. Outdoor RH or Dew point:** Outdoor RH or Dew point is a good LCT reset source in 100% outdoor air applications, where constant dehumidification and reheat is being performed. As the outdoor air humidity becomes more mild, the need to dehumidify to lower LCT's is reduced and can be reset higher to save energy. For example, a 100% OA unit may be designed to supply 68°F/52°F dew point air at design summer conditions, but during cool rainy weather a lower LCT may be desired to provide extra dehumidification to the space. Resetting based on outdoor air humidity above 70% could provide added dehumidification under rainy conditions.

## Dehumidification Menus

### Dehumidification Status

The Dehumidification Menu is a view status menu that displays all relevant Dehumidification Status items.

**Table 23: Main Menu \ View Status \ Dehumidification**

Menu Display Name	Default	Range	Description
Dehum Status	-	Inactive Active	Dehum Status is a status only item which indicates the status of operation of the dehumidification operation. Dehumidification operation can be active or inactive.
Rel Hum 1	-	0-100%	Rel Hum1 is a status only item that displays the current relative humidity reading from the optional relative humidity sensor at user defined location 1.
Rel Hum 2	-	0-100%	Rel Hum2 is a status only item that displays the current relative humidity reading from the optional relative humidity sensor at user defined location 2.
Dew point 1	-	-50.0-150.0°F	Dew point 1 is a status only item that displays the current dew point value that is calculated by the controller using the Rel humidity and Temperature at user defined location 1.
Dew point 2	-	-50.0-150.0°F	Dew point 2 is a status only item that displays the current dew point value that is calculated by the controller using the Rel humidity and Temperature at user defined location 2.
Reheat Spt	-	40.0-100.0°F	Reheat Spt is a status only item that displays the current reheat set point the reheat system is controlling to during dehumidification operation.
Rht Capacity	-	0-100%	Reheat Cap is a status only item that indicates the current reheat capacity value.

### Dehumidification Setup

The Dehumidification Menu is a view status menu that displays all relevant Dehumidification status items.

**Table 24: Main Menu \ View Status \ Dehum Set-Up**

Menu Display Name	Default	Range	Description
Dehum Method	None	None RelHum1 RelHum2 RelHum12 DewPt1 DewPt2 DewPt12	Dehum Method is an adjustable item used to set the dehumidification method to either "RH" or "DewPt." When this parameter is set to RH1, RH2, or RH12, dehumidification operation is controlled to maintain the Rel Humidity value at the Relative Humidity Set Point(s) based on the selection. When this parameter is set to DewPt1, DewPt2, DewPt12, dehumidification operation is controlled to maintain the Dew Point= value at the Dew Point Set Point(s). The location/type of sensor driving the RH or DewPt at 1,2, or 12 is configured in the Humidity Sensor Set Up menu. When this parameter is set to "Always" dehumidification will be active as long as mechanical cooling is not disabled.
Rel Hum1	-	0-100%	Rel Hum1 is a status only item that displays the current relative humidity of humidity sensor 1.
Rel Hum2	-	0-100%	Rel Hum2 is a status only item that displays the current relative humidity of humidity sensor 2.
Hum1 Spt	50%	0-100%	Hum1 Spt is an adjustable item used to set the relative humidity value at sensor location 1 at which the relative humidity will be controlled to during dehumidification operation.
Hum2 Spt	50%	0-100%	Hum2 Spt is an adjustable item used to set the relative humidity value at sensor location 2 at which the relative humidity will be controlled to during dehumidification operation.
Dew point 1	-	-50.0-150.0°F	Dew point 1 is a status only item that indicates the current dew point value that is calculated by the controller using the Rel Humidity= value and either the Space Temp= Air= value, depending on the setting of the Humidity Sensor Location. This parameter can either be set to "Space" or "Return".

Menu Display Name	Default	Range	Description
Dew point 2	-	-50.0-150.0°F	Dew point 2 is a status only item that indicates the current dew point value that is calculated by the controller using the Rel Humidity= value and either the Space Temp= Air= value, depending on the setting of the Humidity Sensor Location. This parameter can either be set to "Space" or "Return".
Dewpnt 1 Spt	50°F	0.0-100.0°F	Dewpnt Spt 1 is an adjustable item used to set the dew point value at location 1 at which the dew point with will be controlled to during dehumidification operation.
DewPnt 2 Spt	50°F	0.0-100.0°F	Dewpnt Spt 2 is an adjustable item used to set the dew point value at location 2 at which the dew point with will be controlled to during dehumidification operation.
Rel Hum DB	6%	0-10%	Rel Hum DB is an adjustable item that sets a dead band around the relative humidity set point. For example, if the RH Set point parameter is set to 50% and the RH Db parameter is set to 2% the dead band around the set point would be from 49% to 51%.
Dew point DB	2.0°F	2-10.0°F	Dew point DB is an adjustable item that sets a dead band around the dew point set point. For example, if the DewPoint Spt parameter is set to 50°F and the DewPntDb parameter is set to 2°F the dead band around the set point would be from 49°F to 51°F.
LCT Set point	55°F	42.0-70.0°F	LCT Set point is an adjustable item which is used to set the leaving coil temperature set point the compressors control to maintain during Dehumidification operation.
LCT Deadband	2.0°F	1.0-10.0°F	An adjustable item used to set the Leaving Coil Set point Deadband.
LCT Spt Reset	None	None Network Space Return OAT Airflow SpaceH1 SpaceH2 OAH RAH SpcDpt1 SpcDpt2 OADwpt RADwpt Hum1PI Hum2PI Dwpt1PI Dwpt2PI	LCT Spt Reset is an adjustable item which is used to set the variable that will be used to reset the leaving coil temperature set point.
Min LCT Spt	45°F	42.0-70.0°F	Min LCT Spt is an adjustable item which sets the minimum leaving coil temperature set point for use with a leaving coil temperature set point reset schedule.
Min LCT Spt@	0	0-100/ NA °F °C %	Min LCT Spt@ is an adjustable item which sets the value of the sensor input, selected with the leaving coil temperature reset parameter, at which the leaving coil temperature set point is reset to the Min LCT Spt value.
Max LCT Spt	52°F	42.0-70.0°F	MaxCT Spt is an adjustable item which sets the maximum coil temperature set point for use with a leaving coil temperature set point reset schedule.
Max LCT Spt	52°F	32.0-70.0°F	

Menu Display Name	Default	Range	Description
LCTRstRHSpt	50°F	0-100°F	An adjustable item used to set the Leaving Coil Reset Relative Humidity Set point.
LCTRstDptSpt	50°F	0-100°F	An adjustable item used to set the Leaving Coil Reset Dew point Set point.
Max LCT Spt@	0	0-100/ NA °F °C %	Max LCT Spt@ is an adjustable item which sets the value of the sensor input, selected with the leaving coil temperature reset parameter, at which the leaving coil temperature set point is reset to the Max LCT Spt value.
Min Reheat Spt	55°F	40-100°F	Min Reheat Spt is an adjustable item which is used to set the minimum DAT during dehumidification.
Max Reheat Spt	65°F	40-100°F	Max Reheat Spt is an adjustable item which is used to set the maximum DAT during dehumidification.
Reheat Spt	-	40-100°F	Reheat Spt is an adjustable value which is used to set the discharge air temperature set point when the unit is in dehumidification.
DAT Htg DB	2.0°F	1-10.0°F	DAT Htg DB is an adjustable item which sets the deadband around the DAT Htg Spt. If the disch air is within the DB no action is take. For example, if the discharge heating set point is set to 85°F and the Htg DB is set to 2°F the dead band around the set point would be from 83.0°F to 87.0°F.
Unocc Dehum	No	No Yes	Unocc Dehum is an adjustable item which sets if dehumidification is allowed in Unoccupied operation.

# Heating

## Heating Operation

A unit may be configured with one of several optional types of primary **Heating**: Hot Water, Steam, Natural Gas, Propane, or Electric Heat. The options will either be staged or modulating controlled. The unit enters the Heating operating state from the Fan Only operating state when the control temperature falls below the Occupied or Unoccupied Heating Set Point by more than half the Occupied or Unoccupied Heating Deadband. The unit transitions from the Heating to Fan Only operating state when the control temperature rises above the Occupied or Unoccupied Heating Set Point by more than half the Occupied or Unoccupied Heating Dead Band. The unit will also transition from the Heating to Fan Only operating state if heating operation is disabled due to OA ambient lockout.

## Staged Control

**Staged Control** is available for electric and gas heat types.

- **Zone Control:** When the unit first enters the Heating operating state the unit goes directly to Stage # 1. The number of heating stages increases when the time since the last stage change exceeds the stage time, the Projected Control Temperature and the actual Control Temperature are less than the Occ Htg Spt (minus  $\frac{1}{2}$  the deadband), and the DAT is less than the Max DAT Htg Spt. The number of heating stages decreases when the time since the last stage change exceeds the stage time, and the Projected Control Temperature and actual Control Temperature are greater than the Occ Htg Spt (plus  $\frac{1}{2}$  the deadband). The number of heating stages also decreases when the time since the last stage change exceeds the stage time, and the DAT is greater than the MaxDATHtgSpt.
- **DAT Control:** When the unit enters the Heating or Minimum DAT states and all heating is off, the unit goes directly to Heating Stage # 1 so that the first stage of heat is turned on immediately. The number of heating stages increases when the time since the last stage change exceeds the stage time, and DAT is less than the effective DAT set point (DAT staging) or the Min DAT limit (MinDAT staging) by  $\frac{1}{2}$  the deadband. One exception to this is that if the current heating stage is zero, the heating stage can increase without regard to the stage timer. The last stage change exceeds the stage time, and the DAT is greater than the effective DAT set point (DAT staging) or the MIN DAT limit (MinDAT staging) by  $\frac{1}{2}$  the deadband.
- **Min DAT:** The unit enters the Min DAT operating state during occupied operation when neither cooling nor heating is required based on the unit heat/cool changeover function but the discharge air temperature falls below a minimum discharge temperature limit by more than  $\frac{1}{2}$  the deadband. The Min DAT operating state prevents cold discharge air temperatures during what would normally be the Fan Only operating state.

## Modulating Control

Modulating heating control is available with gas, electric, hot water, and steam heating types. There are some differences in the control sequence depending on the heat type installed. The different types are described in the following sections.

- **Zone Control:** When a unit is equipped with a modulating heat type and is performing zone temperature control, the controller will calculate the required Heating DAT set point to maintain the desired Control Temperature (Space or RAT) at the OccHeating Set point. The DAT heating setpoint will not be user adjustable and will be continuously reset between the Minimum discharge air heating setpoint(MinHtg Spt) and the maximum discharge air heating setpoint(MaxHtgSpt).
- **DAT Control:** When a unit is equipped with a modulating heating type and is the heating operating state, the modulating valve or control is modulated to maintain the discharge temperature set point.
- **Min DAT:** If heating is enabled and there is no heating load (normally Fan Only operating state), the controller activates the units heating equipment as required to prevent the discharge air temperature from becoming too cool if the Min DAT Flag (DAT units only) is set to yes in the Heating Menu. The unit enters the Min DAT operating state during occupied operation when neither cooling nor heating is required based on the heat/cool changeover function but the discharge temperature falls below a minimum discharge temperature limit. If the discharge air temperature falls below this minimum discharge temperature limit by more than half the discharge heating deadband, the unit operating state changes from Fan Only to Min DAT. (Note: On VAV or CAV Discharge Control Units, the DAT cooling set point parameter in the Cooling Menu acts as the minimum discharge temperature limit. On CAV Zone Control Units the Min DAT Limit in the Heating Menu acts as the minimum discharge temperature limit.)
- **Gas heat:** On units equipped with modulating gas heat, the Discharge heating set point is limited according to the maximum heat exchanger temperature rise limit. This factory set limit varies by burner model and can be found on the gas heat data plate attached to the unit. The controller does not allow the Discharge heating set point to be set above the current temperature entering the discharge fan by more than this maximum heat exchanger temperature rise limit.

## Heating DAT SetpointReset

The **Heating DAT Set point** may be reset for units with DAT Heating Control. The Discharge Air Temperature Set point will never be set below the Minimum DAT Heating Set point or above the Maximum DAT heating Set point on the Heating Reset menu. The reset type may be set to one of the following:

- **None:** Discharge Heating Spt is user adjustable
- **Network:** Discharge Heating Spt is equal to the Network DAT Htg Set point when it is valid
- **Space:** Discharge Heating Spt is based on the Space Sensor
- **Return:** Discharge Heating Spt is based on the Return Air Sensor
- **OAT:** Discharge Heating Spt is based on the Outdoor Air Temperature
- **Ext Signal:** Discharge Heating Spt is determined by a 0-20 or 4-20 mA signal by a 0-10 or 2 - 10 VDC signal

Reset reverts from Return to None when the return air sensor opens or shorts. Reset reverts from Space to None when the space sensor opens or shorts. Reset reverts from OAT to None when the outdoor air sensor opens or shorts.

When Space, Return, OAT, Ext mA, or Ext V is selected, the Discharge Heating Spt equals the Max Htg Spt when the selected value equals the Max Htg Spt @ value. Similarly, the Discharge Heating Spt equals the Min Htg Spt when the selected value equals the Min Htg Spt @ value.

When Space, Return, or OAT is selected, the reset schedule should be set so that the DAT Heating set point decreases as the selected temperature increases as shown in the graph.

When Ext mA is selected, the values "Min Htg Spt @" and "Max Htg Spt @" are entered as mA values. When Ext VDC is selected, the values "Min Htg Spt @" and "Max Htg Spt @" are entered as VDC values.

If Ext mA or Ext V is selected as the type of reset, the Min Htg Spt @ value may be set above the Max Htg Spt @ value to cause a decrease in the DAT set point as the external signal or the Min Htg Spt @ value may be set below the Max Htg Spt @ value to cause an increase in the DAT set point as the external signal increase.

**Figure 27: Heating DAT Reset**

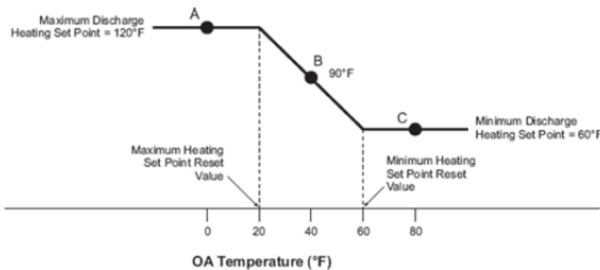

## Special Gas Heat Start Up for 100% OA Units

A special start sequence is used for 100% outdoor air units with gas heat. The special start sequences applies to both Zone Control and DAT Control units. If heat is required at unit start up, the furnace enters a special burner startup sequences as the unit enters its Startup operating state. Pre-firing the burner allows the gas heat pre-purge sequences to occur and the burner to fire and warm up so that tempered air is available immediately when the fans start.

- **Initiation 100% OA Zone Control:** The 100% OA gas heat sequence is initiated at startup if the control temperature is less than the Effective Occupied or Unoccupied Heating Setpoint by  $\frac{1}{2}$  of the Heating deadband or the OAT is less than the Min DAT Limit by the amount of the DAT heating deadband.
- **Initiation 100% OA DAT Control:** The 100% OA gas heat sequence is initiated at start up if the Min DAT Ctrlk parameter is set via the keypad and the OAT is less than the DAT Clg Spt by the amount of the DAT heating deadband.
- **The Sequence:** The special start up sequence is initiated during the Start up operating state, the fans remain off, and the main gas valve is energized so the burner starts during the Warm up Time (default =45s) and operates at low fire. At the end of the warmup time, the modulating gas valve is set to a position based on the calculated application requirements. Once the gas valve is set to the calculated position, a HeatUpDely starts (default =240s) to allow the heat exchanger to heat up. After this delay, since the unit is 100% Outside Air, the unit immediately transitions from Startup to the Fan Only State. As soon as the unit enters the Fan Only Stat, the unit will immediately transition to the Heating State or MinDAT.

## Outdoor Air Ambient Heating Lockout

Heating is disabled whenever the outdoor air temperature is greater than the **Outdoor Air Ambient Heating Lockout Set Point**. When the outdoor air temperature drops below the Outdoor Air Ambient Heating Lockout Set Point by more than the Heating Lockout Differential, heating operation is re-enabled. Cooling is disabled if outdoor air temperature or entering water temperature is too low for operation. The outdoor air temperature becomes too low for operation when it drops below the Outdoor Air Ambient Cooling Lockout Set Point. Outdoor air temperature becomes high enough for operation when it rises above the Outdoor Air Ambient Cooling Lockout Set Point by more than the Cooling Lockout Differential. The entering water temperature becomes too low for operation when it drops below the Minimum Entering Water Temperature Set point. Entering water temperature becomes high enough for operation when it rises above the Minimum Entering Water Temperature Set point by more than the Cooling Lockout Differential.



## Post Heat Operation

**Post Heat Operation** is a time delay feature used in duct pressure VAV systems that utilize the VAVBoxOut digital output or network command (DO10, or network variable) in the unit MicroTech controller. The VAV Box output varies from off (heat mode to On (cool mode) to tell the VAV boxes what state the unit is operating in. Post heat operation is a time delay for switching the VAV box output function from heat to cool. The intention of this timer is to allow the supply fan capacity to be reduced to the Minimum supply fan capacity to help prevent high duct pressure conditions during transitions that may otherwise occur due to the relative faster response of the VAV boxes versus the supply fan. Post heat operation remains active until either the discharge fan capacity reaches the minimum value, or until the Post Heat Timer Expires, whichever occurs first.

**NOTE:** During “post heat” operation and for 120 seconds afterward, the proof of airflow input is ignored. This is to prevent nuisance Fan Fail fault alarms that may occur if the airflow switch opens during or following post heat operation. The unit cannot leave Fan Only or Min DAT operation while the airflow switch is being ignored.

## Freezestat

When a unit is equipped with chilled water, hot water, or steam coil, a freeze problem occurs when the optional **Freezestat** contacts open as a result of detecting an abnormally low water or steam coil temperature while the fans are off.

When the freeze problem occurs, the controller opens the chilled water and heating valves and sets a 10-minute timer. When the 10-minute timer expires, the controller checks the freezestat input again. If the freezestat contacts are closed, the pump output is de-energized and the valves close. If the freezestat contacts are still open, the pump output remains energized, the valves remain open, and the 10-minute timer resets. This continues while the unit remains off. Whenever the freezestat closes, the Freeze problem automatically clears. This feature protects the coil(s).

## Heating Menus

### Heating Status

The Heating Menu is a view status menu that displays all relevant Heating status items.

**Table 25: Main Menu \ View Status \ Heating**

Menu Display Name	Default	Range	Description
Htg Capacity	-	0-100%	Htg Capacity is a status only item which indicates the percentage of the unit maximum heating capacity currently operating.
2nd Htg Cap	-	0-100%	2nd Htg Cap is a status only item that displays the current secondary heat source capacity.
Htg Status	-	Enabled None OffAmb OffAlm OffNet OffMan	Htg Status is a status only item which indicates whether or not heating is currently allowed. If heating is disabled, the reason is indicated.
2nd Htg Status	-	Enabled None OffAmb NA OffNet OffMan NA	A status only item indicating the current Secondary Heating source Status.
Htg Stg 1	-	On Off	Htg Stg 1 is an adjustable item that turns on the first stage of heat on units equipped with staged heating.
Htg Stg 2	-	On Off	Htg Stg 2 is an adjustable item that turns on the second stage of heat on units equipped with staged heating.
Htg Stg 3	-	On Off	Htg Stg 3 is an adjustable item that turns on the third stage of heat on units equipped with staged heating.
Htg Stg 4	-	On Off	Htg Stg 4 is an adjustable item that turns on the fourth stage of heat on units equipped with staged heating.

### Heating Set-Up Menu

**Table 26: Main Menu Commission Unit \ Heating Set-Up Menu**

Menu Display Name	Default	Range	Description
Control Temp	-	-461.2- 525.2°F	Control Temp is a status only item which displays the current value of the "Control Temperature." The "Control Temperature" is defined as the temperature input selected by the Control Temperature Source parameter. For example, if the Control Temperature Source parameter is set to "Return," then the control temperature parameter reads the same value as the Return Air parameter.
Occ Htg Spt	68.0°F	0.0- 100.0°F	Occ Htg Spt is an adjustable item which indicates the temperature in which the unit will go into the heating mode of operation.
Occ Htg DB	2.0°F	0.0-10.0°F	Occ Htg DB is an adjustable item which sets a dead band around the Occ Heating Set Point parameter. For example, if the Occ Heating Set Point parameter is set to 68°F and the Htg Deadband parameter is set to 2°F the dead band around the set point would be from 70.0°F to 66.0°F.
Disch Air	-	-50.0- 250.0°F	Disch Air is a status only item which displays the current temperature reading from the unit's discharge air temperature sensor (DAT). This sensor is standard on all units.

Menu Display Name	Default	Range	Description
DAT Htg Spt	85.0°F	40.0-105.0°F	DAT Htg Spt is an adjustable item which sets the temperature that the DAT should be maintained at when it is in the heating mode of operation. This value is adjustable on DAC and 1ZnVAV units. It is not adjustable on CAV units.
DAT Htg DB	2.0°F	1.0-10.0°F	DAT Htg DB is an adjustable item which sets the deadband around the DAT Htg Spt. If the disch air is within the DB no action is taken. For example, if the discharge heating set point is set to 85°F and the Htg DB is set to 2°F the dead band around the set point would be from 83.0°F to 87.0°F.
Eff Space T	-	0.0-150.0°F	Eff Space T is a status only item that displays the current effective space temperature.
Unocc Htg Spt	55.0°F	40.0-100.0°F	Unocc Htg Spt is an adjustable item which sets the zone temperature below which the unit starts up and provides unoccupied heating (night setup) during unoccupied periods. NOTE: Setting this to its maximum value will disable unocc heating.
Unocc Diff	3.0°F	0-10.0°F	Unocc Diff is an adjustable item which sets a differential above and below the Ucc Htg Spt. Heating operation is enabled when the Control temp is below the Unocc Htg spt by the unocc diff. Conversely, Heating operation is disabled when the control temp is above the Unocc HtgSpt by the Unocc Diff.
Htg Stg Time	5 min	2-60min	Htg Stage Time is an adjustable item used to set a minimum time period between compressor stage changes.
OA Temp	-	-50.0-200.0°F	OA Temp is a status only item which displays the current temperature reading from the unit mounted Outdoor air temperature sensor. This sensor is standard on all units.
Htg Hi OAT Lk	55°F	0-100°F	Htg Hi OAT Lk is an adjustable item which sets the maximum outdoor air temperature heating lockout point. Heating operation is disabled when the outdoor air temperature sensor input rises above this set point.
OAT Diff	2.0°F	0-10.0°F	OATDiff is an adjustable item which sets a differential below the OAT Htg Lock parameter. Heating operation is re-enabled when the outdoor air temperature sensor input falls below the OAT Htg Lock value by more than this differential.
Htg Reset	None	None Network Space Return OAT ExtmA ExtV	Htg Reset is an adjustable item that is used to set the type of heating reset to be used.
Min Htg Spt	55.0°F	40.0-130.0°F	Min Htg Spt is an adjustable item which sets the minimum heating discharge set point for use with a heating discharge air temperature set point reset schedule.
Min Htg Spt@	0	0-100/ NA °F °C mA V	Min Htg Spt @ is an adjustable item which sets the value of the sensor input, selected with the Heating Reset parameter, at which the DAT heating set point parameter is reset to the minimum DAT heating set point value.
Max Htg Spt	65.0°F	40.0-105.0°F	Max Htg Spt is an adjustable item which sets the maximum heating discharge set point for use with a heating discharge air temperature set point reset schedule.
Max Htg Spt@	100	0-100/ NA °F °C mA V	Max Htg Spt @ is an adjustable item which sets the value of the sensor input, selected with the Heating Reset parameter, at which the DAT heating set point parameter is reset to the maximum DAT heating set point value.

Menu Display Name	Default	Range	Description
Min DAT Ctrl	Yes	No Yes	Min DAT Ctrl is an adjustable item which determines whether or not MinDAT operation is allowed. When set to No, the unit will not enter MinDAT tempering during Fan Only Operation.
Min DAT Limit	55.0°F	0.0-70.0°F	Min DAT Limit is a status item that indicates the discharge air low limit temperature on CAV zone control units. Heating will be activated to maintain this setting when the discharge temperature falls below it during the Fan Only operating state. On VAV or CAV discharge control units, the minimum discharge temperature limit is the DAT Clg Spt. Once a valid password has been entered this item becomes an adjustable item.
MWU Sensor	CtrlTemp	CtrlTemp RAT Space None	MWU Sensor is an adjustable item that sets the temperature sensor input to be used for morning warmup heating operation on discharge air control units. Setting this parameter to none disables morning warm up operation.
StgGPriState	-	Lckout Retry Off PrePg IgnOn GasOn Warmup Run No Comm	StgGPriState is a status item that indicates the Previous State of the staged gas furnace control board. This board is communicating via modbus. For detail on the gas heat states see the Appendix Section labeled Gas Furnace Controller Diagnostics.
StgG1PriState=	-	Lckout Retry Off PrePg IgnOn GasOn Warmup Run No Comm	A status only item which indicates the state of the staged furnace Primary control board 1.
StgG2PriState=	-	Lckout Retry Off PrePg IgnOn GasOn Warmup Run No Comm	A status only item which indicates the state of the staged furnace Primary control board 2.

Menu Display Name	Default	Range	Description
StgG3PriState=	-	Lckout Retry Off PrePg IgnOn GasOn Warmup Run No Comm	A status only item which indicates the state of the staged furnace Primary control board 3.
StgGSpltState=	-	Lckout Retry Off PrePg IgnOn GasOn Warmup Run No Comm	A status only item which indicates the state of the furnace Split manifold control board.
StgG1DiagCode=	-	None 11-15 21-25 31-35 41-45 51 54-55 NoComm NA	StgGDiagCode is a status item that indicates a diagnostics codes for the staged gas furnace control board. For detail on the gas heat diagnostic codes see the Appendix Section labeled Gas Furnace Controller Diagnostics.
StgG2DiagCode=	-	None 11-15 21-25 31-35 41-45 51 54-55 NoComm NA	A status only item which indicates a diagnostics code for the staged gas furnace control board 2.
StgG3DiagCode=	-	None 11-15 21-25 31-35 41-45 51 54-55 NoComm NA	A status only item which indicates a diagnostics code for the staged gas furnace control board 3.

Menu Display Name	Default	Range	Description
ModGState		Lckout Retry Off PrePg IgnOn GasOn Warmup Run No Comm	ModGState is a status item that indicates the current state of the modulating gas furnace control board. This board is communicating via modbus. For detail on the gas heat states see the Appendix Section labeled Gas Furnace Controller Diagnostics.
ModGDiagCode		None 1-15 18-20 22-24 33-34 No Comm	ModGDiagCode is a status item that indicates a diagnostics codes for the modulating gas furnace control board. For detail on the gas heat diagnostic codes see the Appendix Section labeled Gas Furnace Controller Diagnostics.
ModGErrCode		None 3-4 6-8 10 18 22 26 28-29 NoComm NA	ModGDiagCode is a status item that indicates a diagnostics codes for the modulating gas furnace control board. For detail on the gas heat diagnostic codes see the Appendix Section labeled Gas Furnace Controller Diagnostics.
EF/LC Temp	-	-50.0- 200.0°F	A status only item which indicates the air Temperature between the DX coil and supply fan.

# Outside Air Damper

## Outside Air Damper Operation

Units may be configured with a 100% **Outdoor Air (OA) Damper**, a 0-100% OA Economizer, or a 0-30% OA damper. During occupied normal operation, units with a 0-30% OA or 0-100% OA economizer damper control to a minimum outdoor air position, which is determined from a number of control factors, including: fans speed, CO2, or other reset methods. Control of the dampers in the Economizer state is described “**Economizer Control**” on page 77.

## 100% Outside Air Damper Operation

**100% Outside Air (OA)** two position actuators are controlled by an analog output so the OA damper is driven to 100% open position when the OA damper analog output is at its maximum value and it is driven closed when the OA damper analog output is at its minimum value. In units equipped with a 100% OA Damper the OA damper is open during the start period and it remains open during all operating states. The OA damper remains open after the fan is turned off until 30 seconds after the airflow status indicates a loss of airflow. This keeps the outside air damper open in case there is a failure or external override that keeps the fan running after it is turned off by controller logic.

## 0-30% Outside Air Operation

A two position **0-30% Outside Air (OA)** actuator is controlled by a modulating analog output. This actuator is driven to its fully open position, nominally 30%, when the OA damper analog output is at its maximum value, and it is closed when the OA damper analog output is at its minimum value. The desired minimum open position between 0 and 30% is normally set by an editable keypad menu item (Vent Limit). The two position damper is driven to the closed position when the supply fan is OFF

(OFF and Startup state), the unit is in the Recirculation state, unoccupied operation is active, or the fan has been on for less than the Zero OA Time. As a result, the OA dampers are driven closed in unoccupied operation, and morning start-up situations. The two position damper is driven to the desired minimum open position in all other conditions.

## 0-100% Outside Air Economizer Operation

A 0-100% outdoor air economizer damper is controlled by a modulating analog output. This actuator is driven to its fully open position - nominally 100%, when the OA damper analog output is at its maximum value, and it is closed when the OA damper analog output is at its minimum value. The desired minimum open position between 0 and 100% is normally set by an editable keypad menu item (Vent Limit). The modulating damper is driven to the closed position when the supply fan is OFF, (OFF and Start up states), the unit is the recirculation state, unoccupied operation is active, or the fan has been on for less than the Zero OA time. The modulating damper is driven to the desired minimum open position in all other conditions. Control of the dampers in the Economizer state is described “**Economizer Control**” on page 77.

## Outside Air Damper States

The minimum OA Position is set to zero, or the closed position, when the supply fan is Off, the unit is in the recirculation state, Occupancy is set to Unocc, or the fan has been on for less than the Zero OA Time.

Outdoor air damper control varies, by damper type, occupancy and unit state. If unoccupied operation occurs, the OA damper is always closed and unoccupied condition occurs while recirculating air. In occupied operation, the OA damper will operate in one of three control states: closed, Min OA control, or Economizer control.

**Table 27: Main Menu \ View Status \ Dehumidification**

	Unit State	OA Damper Control States/Damper Type		
		0-30% OA	0-100% OA Econo	100% OA
Occupied	Off, Start Up, Recirculation	Closed	Closed	Closed
	Cooling, Heating, Fan Only, Min DAT	Min OA Control	Min OA Control	100%
	Economizer	NA	Economizer Control	NA
Unoccupied	Any State	Closed	Closed	100%

## Closed Operation

In the occupied mode in the Off, Start-up and Recirculation unit states the OA damper position is always closed. In the unoccupied mode the outdoor air damper is always closed and with a 0-100% economizer damper, the recirculation damper is open.

## Minimum Outside Air Damper Control

When a unit is equipped with a 0-30% OA or 0-100% OA modulating economizer damper the effective minimum ventilation position (Min OA position) is controlled using a minOA process. In occupied cooling, heating, fan only, and min DAT unit state operation, the damper will operate following the Minimum OA control Sequences.

There are several key minimum outside air damper control process definitions required to understand this process.

- Ventilation Limit:** Ventilation limit process line sets the maximum outdoor air damper position required based on the outdoor air volume required space and occupancy during regular occupied operation. This damper position varies between two setpoints, the VentLimit, and the LoFlow Vent limit (LoFloVentLmt) as the SAF capacity varies from maximum to minimum respectively.

- Demand Control Ventilation Limit:** The DCV limit process line sets the minimum damper positioned allowed based on the a minimum outdoor air reset. For this line to be relevant the minimum outside air reset type cannot be set to None. This process line will vary based on fan speed and varies based on the variation in the ventilation limit. The DCV Limit cannot be set higher than the Vent Limit.
- Minimum Outdoor Air Reset:** The Min OA Reset varies the effective damper position between the DCV limit (DCVLimit) (minimum) and the Ventilation Limit (VentLimit) (maximum) based on an external variable like a network signal, external signal, or a CO2 Sensor.
- Outdoor Airflow Reset:** Units equipped with an Outdoor air flow measuring station will control the minimum damper position based on the greater of the three damper positions, DCV Limit (minimum), the Minimum OA Reset Method or The Outdoor Airflow Reset. If the Outdoor Airflow set point, CFM, requires a greater damper position than the Min OA Reset, then the minimum OA damper position will be driven based on the Outdoor Airflow Set point.

Figure 28: Outdoor Air Damper Reset

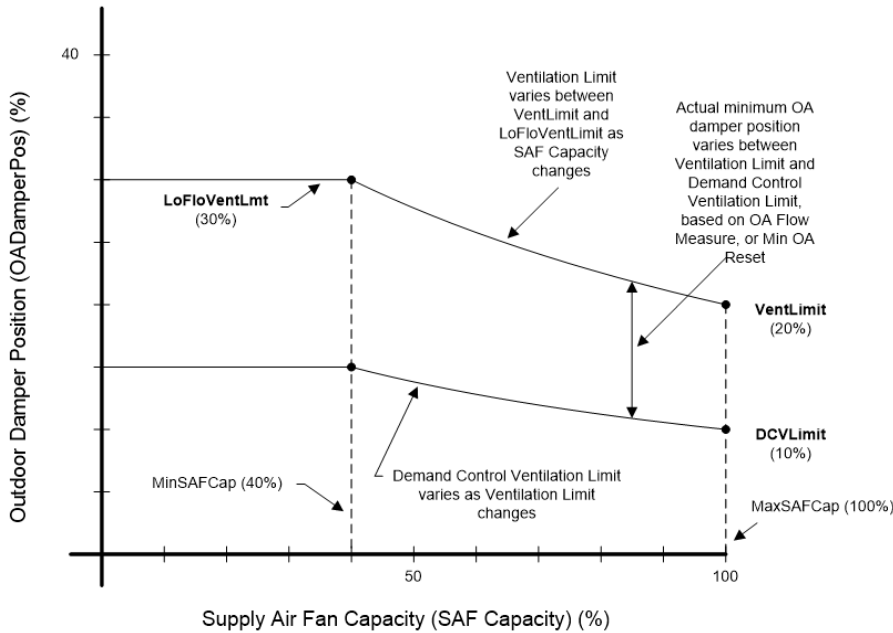



## Minimum Outside Air Reset Types

- **None:** If The minimum Outside Air Reset is selected as None, the Minimum OA Damper position is always equal to the Ventilation Limit. The Demand Control Ventilation Limit is not applicable, and can be ignored.
- **Network Control:** If Network is selected as the Min OA Reset Type and a valid value for the minimum position is provided via a network the Minimum OA position is set equal to that value. The network is only allowed to write a value that is between the Ventilation Limit and the Demand Control Ventilation Limit. If the Min OA Reset Type is set to Network and a valid minimum position is not provided, the Min OA Damper Position is set equal to the Ventilation Limit.
- **External Signal:** If the ExtSig is selected as the Min OA Reset Type, the Minimum OA position is calculated based on an external analog 0-10 VDC, 0-20 mA signal or a CO2 sensor input. The CO2 sensor range can be adjusted to control between the Demand Control Ventilation Limit CO2 PPM (minimum) and a Ventilation Limit CO2 PPM (maximum). The Minimum OA damper position will vary linearly between the DCV and Vent Limit positions as these the CO2 input (PPM) varies between these points.

## Recommended Reset Settings

These example settings are for illustration purposes; real application settings may vary.

- For units with the Reset Type selected as None the only parameters that require commissioning are the Vent Limit and LoFlow Vent Limit (if the unit is VAV).
- For units with Reset Type selected as Network, to give the network complete control over the damper, the DCV and Vent Limits need to be set to 0% and 100% respectively.
- For units with Reset Type selected as Ext Signal, to give the external signal complete control over the damper the for the 0-10 VDC and 0-20 mA signal ranges the DCV and Vent limits need to be set to 0% and 100% respectively.
- For units with Reset Type selected as Ext Signal for use with CO2, the minimum signal is the MinPPM@ the DCV limit damper position and the max signal is the MaxPPM@ the Vent limit damper position.

**Table 28: Main Menu \ View Status \ Dehumidification**

OA Damper Set-Up Parameters	None	Network	Ext Signal		
			VDC (0-10)	mA (0-20)	CO2 (See Note)
Min Signal	NA	0%	0V	0 mA	4 PPM
DCV Limit	NA	0%	0%	0%	1
Max Signal	NA	100%	10V	20 mA	4 PPM
Vent Limit	2	100%	100%	100%	2
LoFlow Vent Limit	3	100%	100%	100%	3
OA @ Min	NA	NA	0%	0%	NA
OA @ Max	NA	NA	100%	100%	NA

**NOTE:** NA - Not Available

**NOTE:** DCV Limit damper position is set at 100% SAF Capacity minimum occupancy outside air volume required by application

**NOTE:** Vent Limit damper position is set at 100% SAF Capacity maximum occupancy outside air volume required by application

**NOTE:** LoFloVent Limit damper position is set at minimum SAF Capacity, maximum occupancy outsider air volume required by application

**NOTE:** Min Signal is PPM @ DCVlimit and Max Signal is PPM@Vent Limit

## Damper Override Operations

There are several scenarios where a unit operating in occupied minimum outside air control can be configured to override damper position.

- **Zero OATime:** Upon Occupied start up, a zero OA timer can be configured to hold the damper shut for a predetermined time. This timer starts once the unit first enters Fan Only upon occupied start up. See Timer Settings on how to set this Timer.
- **Optimal Start/Morning Warm-Up:** During Optimal Start/Morning Warm-Up/Morning Cool Down operation, the outdoor air damper is held shut for the duration of the optimal start sequence where the Zero OA Timer is set equal to the Optimal start time. See “[Optimal Start \(Morning Warm-Up/Cool Down\)](#)” on page 28 for details on how this sequence works.
- **Building Static Pressure Override:** When the unit is equipped with a 0-30% OA or 0-100% OA modulating economizer and a building static pressure sensor the minimum outside air position may be overridden to maintain building pressure when the exhaust fan is at minimum capacity, off, or not present. To activate this override feature, the building pressure override flag must be set to yes. The damper position will be overridden when the exhaust fan, if present, is at minimum capacity and the building static pressure is below the building static pressure set point by more than half of the dead band for a stage timer. Once building pressure override is active, the damper will modulate to maintain the building pressure set point.

## Cold Start Operation

A special “**Cold Start**” sequence will slow the opening of the dampers when it is cold outdoors and the unit is equipped with either Hot water/Steam or Face and Bypass heating. This is to try to prevent nuisance freeze trips associated with dampers opening up rapidly to minimum position before the heat has a chance to ramp up. The “cold start” sequence is initiated if the following conditions are all true.

- OAT is below the current LoDAT Limit
- The unit equipped with an Air side Economizer
- The current Unit State is beyond the Recirc
- The current Minimum Outdoor Damper Position set point is greater than 0%
- The unit is equipped with Hot water/Steam or F& BP heating

When the sequence is active the dampers will move more slowly the colder it is outdoors. The minimum and maximum ramp rates are adjustable via the keypad by navigating to the commission unit/Min OA Set-Up menu. The effective ramp rate will vary from Minimum 40% 100% (Minimum) Airflow rate at OAT equal to -30°F to the maximum at OAT equal to 100°F. Once the damper position reaches a point 1% below the actual effective minimum position normal operation will begin. If the unit enters the Economizer operating state before the damper regulation begins, the regulation will begin from the current economizer position.

## OA Damper Commissioning

Common **OA Damper** menu items that need to be configured at commissioning are the Vent Limit, LoFloVent Limit, DCV Limit, and MinOA Reset, CO2, or Flow reset.

# OA Damper Menus

## OA Damper Set-Up

**Table 29: Main Menu \ Commission Unit \ OA Damper Set-Up**

Menu Display Name	Default	Range	Description
Vent Limit	20%	0-100%	Vent Limit is an adjustable item that sets the value of the Ventilation Limit on a CAV unit or when a VAV unit is at 100% discharge fan speed.
LoFlo VntLmt	30%	0-100%	LoFlo Vent Limit is an adjustable item that sets the maximum value for the Ventilation Limit on a VAV unit. The ventilation limit is raised toward this value as the discharge fan speed decreases toward the Min Clg Cap value.
DCV Limit	10%	0-100%	DCV Limit is an adjustable item that sets the value of the Demand Control Ventilation Limit on a CAV unit or when a VAV unit is at 100% discharge fan speed. This item is only used when the "CO2 Reset" is set to "Yes".
OAD Position	-	0-100%	OAD Position is a status only item which displays the current OAD position.
Min OA Pos	-	0-100%	Min OA Pos is a status only item which indicates the current minimum position of the outdoor damper. This value does not go above a value called the Ventilation Limit and does not go below a value called the Demand Control Ventilation Limit.
Min OA Src	-	VentLmt OAFIw ExtSig CO2 Network BSP RstTLmt FanDlff ZeroOA	Min OA Src is a status only item that indicates the action that is winning for control of the OA damper position.
<b>NETWORK RESET</b>			
Network Reset	No	No Yes	An adjustable input to enable/ disable Network Reset of the effective minimum ventilation position.
Net Min OA	-	0-100%	A status only item which indicates the Network Minimum Outside Air Damper position.
<b>EXT AI RESET</b>			
Ext AI Reset	Yes	No Yes	An adjustable input to enable/ disable External Analog Input Reset of the effective minimum ventilation position.
OA @ MinV/mA	0%	0-100%	OA @ MinV/mA is an adjustable item used when Min OA Reset= is set to "ExtSig" to define the Min OA Pos= is when the field signal is at minimum value. NOTE: Min OA Pos= is limited above the Demand Control Ventilation Limit.
OA @ MaxV/mA	100%	0-100%	OA @ MaxV/mA is an adjustable item used when Min OA Reset= is set to "Ext VDC" or "ExtSig" to define the Min OA Pos= when the field signal is at the minimum value. NOTE: Min OA Pos= is limited below the ventilation limit.
Ext Signal	-	0-50.0	A status only item which indicates the External Minimum Outside Air Damper position.
<b>CO2 RESET</b>			
CO2 Reset	Yes	No Yes	CO2 Reset is an adjustable item used to determine if CO2 reset is being used to control the Min OA damper position.
PPM @ DCV Lmt	800ppm	0-5000ppm	PPM @ DCV Lmt is an adjustable item used when Min OA Reset= is set to "ExtSig" to define at what PPM value the Min OA Pos= is to be at the Demand Control Ventilation Limit value.

Menu Display Name	Default	Range	Description
PPM @ Vnt Lmt	1000ppm	0-5000ppm	PPM @ Vent Lmt is an adjustable item used when Min OA Reset= is set to "ExtSig" to define at what PPM value the Min OA Pos= is to be at the Ventilation Limit value.
CO2 PPM	-	0-5000ppm	CO2 PPM is a status only item which displays the current CO2 PPM reading.
CO2SensorSrc	QMX1	QMX1 QMX2 QMX3	An adjustable input to select CO2 Sensor Source.
<b>FLOW RESET</b>			
OA Flow Reset	No	No Yes	OA Flow Reset is an adjustable item that allows or disallows the Outdoor air flow to reset the Outdoor air damper.
OA Flow	-	0-60000CFM	OA Flow is a status only item that displays the current outdoor air flow CFM.
OA Flow Spt	2000CFM	0-60000CFM	OA Flow Spt is an adjustable item that sets the Outdoor airflow cfm that the PI_loop will modulating the SAF capacity to maintain.
OA Flow DB	3%	0-100%	OAFLOW DB is an adjustable item that sets a deadband around the OA Flow Set point.
<b>BSP RESET</b>			
BSP OA Ovrd	No	No Yes	BSP OA Ovrd is an adjustable Setting that allows or disables the building static pressure override feature.
Bldg Press	-	-0.250- 0.250in	Bldg Press is a status only item indicated the current building static pressure reading.
BldgSP Spt	0.050in	-0.250- 0.250in	BldgSP Spt is an adjustable item which sets the current building static pressure set point.
BSP DB	0.010in	0.000- 0.100in	BSP DB is an adjustable item that sets the deadband around the Bldg SP set point that the PI Loop will modulate the exhaust air fan capacity to maintain within.

# Economizer Control

## Economizer Operation

If a unit is equipped with a 0-100% Outside Air **Economizer**, and the outdoor air is suitable for free cooling, the unit attempts to satisfy the cooling load by using the outdoor air before using mechanical cooling. If the control temperature is above the Occupied Cooling Set point by half the deadband and the outdoor air is suitable for free cooling, the unit will enter the Econo State.

The transition from the Econo to Cooling operating state occurs when the economizer is unable to satisfy the cooling load and mechanical cooling is available. This will occur when the commanded economizer position indicates more than 95% open and the discharge air temperature (DAT control units), or the control temperature (Zone control units) is above the applicable Cooling Set point by more than half the applicable Cooling Deadband for longer than the Cooling Interstage Timer.

## Fixed Drybulb Economizer

All units equipped with an **Economizer** can be configured to determine if the outdoor air is suitable for free cooling by using a single, fixed outdoor air dry bulb set point. When the outdoor air temperature is below this set point, the unit will enter economizer mode.

## Comparative Drybulb Economizer

Units equipped with a **Comparative Drybulb Economizer** determine the outdoor air is suitable for free cooling by comparing the return air temperature with the outdoor air temperature.

## Comparative Energy/Enthalpy Economizer

Units equipped with a **Comparative Energy Economizer** determines if the outdoor air is suitable for free cooling by comparing the energy enthalpy of the outdoor air and return air, and the energy to cool to meet the cooling DAT or Zone Set point. There are four operating cases the MicroTech controller compares to evaluate energy efficient economizer control. These cases are summarized in [Table 30](#) The economizer logic evaluates if free cooling is more energy efficient by comparing the Return air dew point against the DAT Spt – an Offset. The offset is to account for fan heat or other factors that move the discharge air away from the saturation line. The default offset is 0.0°F.

**Table 30: Energy/Enthalpy Economizer Offsets**

	Economize Decision Matrix	Outside Air Dewpt (DP2)	
		> DAT Stpt - Offset (DB3)	< DAT Stpt - Offset (DB3)
Return Air Dewpt (DP1)	> DAT Stpt - Offset (DB3)	Case 1 Economize if $h2 < Rh1$	Case 2 Economize if $0.245*(DB2 - DB3) < (h1 - h3)$
	< DAT Stpt - Offset (DB3)	Case 3 Economize if $0.245*(DB1 - (DB3-Offset)) < (h2 - h3)$	Case 4 Economize if $DB2 < DB1$

Notes:

**NOTE:** A key assumption of this table is that DATsetpoint is at saturation and therefore equal to the DAT dew point. This is not always the case and will need to subtract an offset to cover the various applications like remote mounted DAT sensors. The DAT offset should be between 0-10°F.

**NOTE:** Case 2 and Case 3 use simplified formulas for sensible heat transfer rates ( $q = m \times Cp \times \Delta T$ , where  $m$ = mass flow rate of the air,  $Cp = 0.245$  BTU/ lbm °F,  $\Delta T$  is the change in dry bulb temperature (°F)) and total heat transfer ( $q = m \times \Delta h$ , where  $m$ = mass flow rate of the air,  $\Delta h$  is the change in enthalpy)

### Case 1 and 2

The light blue row in Table 30 is represented by Figure 29. The green shaded areas of this chart represent outdoor air conditions where economizing is allowed to occur for cases 1 and 2. Cases 1 and 2 are only valid for cases where the return air dew point is greater than the discharge air set point dew point.

Figure 29: Case 1 and 2

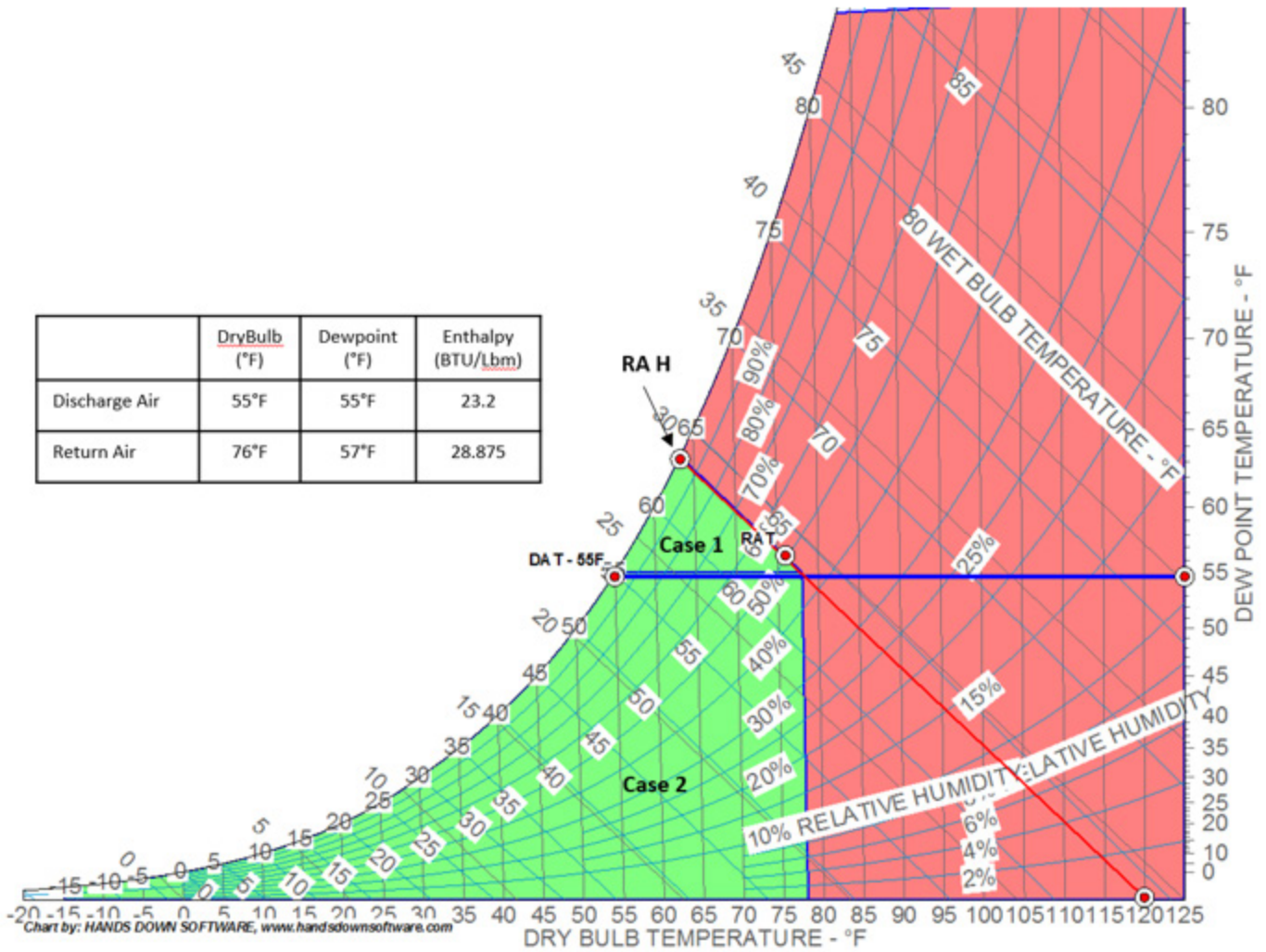

### Case 3 and 4

The light red row in Table 30 on page 77 is represented by Figure 30 below. The shaded green areas of this chart represent the Outdoor air conditions where economizing is allowed to occur for cases 3 and 4. Cases 3 and 4 are valid if the Return air dew point is less than the discharge air set point less the offset.

Figure 30: Case 3 and 4

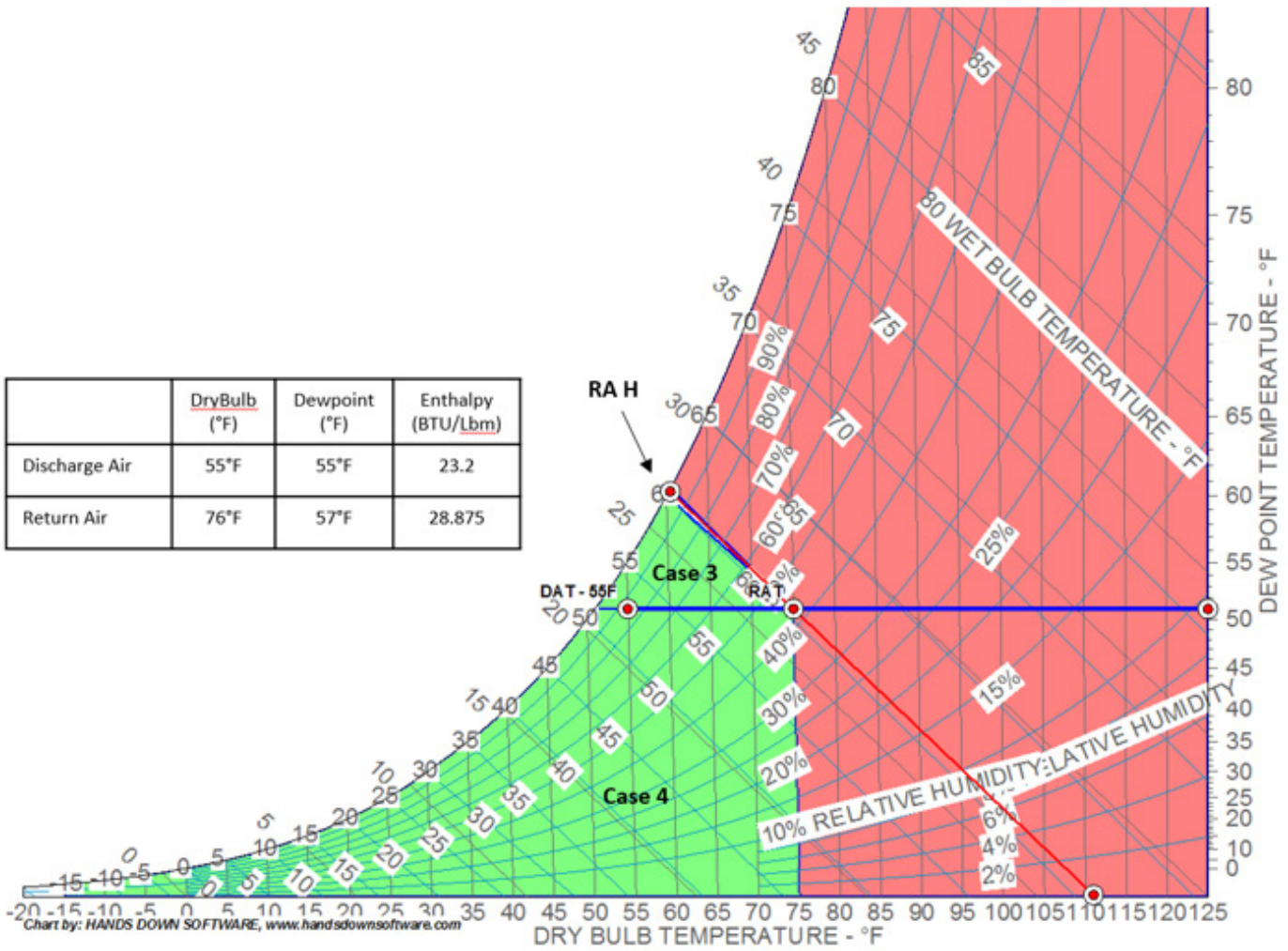

## Economizer Fault Detection Diagnostics

The comparative drybulb and comparative enthalpy economizers are available with an optional Fault Detection Diagnostics function. The economizer fault detection and diagnostics function provides a warning alarm indication of over economizing, under economizing, stuck dampers and excess outdoor air.

## OAD End Switch Calibration

The Outdoor Air Damper (OAD) End Switch input requires calibration function that captures the command position, at which the switches open and close at the closed and open ends of the damper modulation range. This function consists of a manually initiated sequence that strikes the dampers fully open, then fully closed, and detects the changes of state of the switch input and records the points where changes occur. The sequence must be initiated while the Unit State is Off and starting with the end switch input in the closed position.

When the Calibrate OAD parameter is set from No to Yes, the following sequence occurs:

1. The damper command is increased 1% every 2 seconds until the OAD End Switch opens.
2. The damper command is then be decreased 1% every 2 seconds until the OAD End Switch input closes. At this point the current command % is captured.
3. The damper command is increased 1% every 2 seconds until the OAD End Switch input opens. At this point the difference between the current command % and the damper end switch closed value is captured.
4. The damper command is increased and held at 100% until the OAD End Switch input closes.
5. The damper command is decreased 1% every 2 seconds until the OAD End Switch input opens.
6. The damper command is increased 1% every 2 seconds until the OAD End Switch input closes. At this point the current command % is captured.
7. The damper command is decreased 1% every 2 seconds until the OAD End Switch input opens. At this point the difference between the damper open end switch value and the current command % value is captured.
8. The damper command is decreased and held at 0% until the OAD End Switch input closes at which point the values captured in Step 2, Step 3, Step 6, Step 7 are written to the damper end switch open (posSwOpen%), Minimum switch differential (MinSwDiff), damper end switch closed (PosSwClose%) and maximum switch differential (MaxSwDiff) parameters respectively.

Calibrate OAD= parameter is then be set back to No and normal unit operation resumes.

## Economizer DAT Set point

When the unit is in the Econo operating state, the outdoor air dampers are modulate as required to maintain the Discharge Cooling Set Point unless the UseDATClgSpt flag is set to No. If the UseDATClgSpt flag is set to N, then the Economizer DAT Spt is used. The benefit of using the separate economizer DAT spt is that it allows buildings to balance fan or economizer energy to reduce compressor run hours during economizing where possible.

## Economizer DAT Reset

Units with the UseDATClg Spt =No can configure the DAT Econo Spt for use with a Economizer Reset schedule. The Economizer Reset schedule can be used with the following reference sources:

- **None:** Discharge Cooling Spt is user adjustable
- **Network:** Discharge Cooling Spt is equal to the Network DAT Clg Set point when it is valid
- **Space:** Discharge Cooling Spt is based on the Space Sensor
- **Return:** Discharge Cooling Spt is based on the Return Air Sensor
- **OAT:** Discharge Cooling Spt is based on the Outdoor Air Temperature



## Economizer Menus

### Economizer Status

The Economizer Menu is a view status menu that displays all relevant Economizer status item

**Table 31: Main Menu \ View Status \ Economizer**

Menu Display Name	Default	Range	Description
OAD Position	-	0-100%	OAD Position is a status only item which indicates the percentage that the outdoor air damper is currently open.
Min OA Pos	-	0-100%	Min OA Pos is a status only item which indicates the current minimum position of the outdoor air damper.
Econo Status	-	Enabled None OffAmb OffAlm OffNet OffMan Off Dehum	Econo Status is a status only item which indicates whether or not the economizer is currently enabled. If economizer is enabled, the reason is indicated.
FreeClgStatus	-	Unavail Avail	Free Clg Status is a status only item that indicates whether air side economizer free cooling is available or unavailable based on a definable ambient temperature range.

### Econo Set-Up Menu

**Table 32: Main Menu \ Commission Unit \ Econo Set-Up Menu**

Menu Display Name	Default	Range	Description
Control Temp	-	-461.2- 525.2°F	Control Temp is a status only item which displays the current value of the "Control Temperature." The "Control Temperature" is defined as the temperature input selected by the Control Temperature Source parameter. For example, if the Control Temperature Source parameter is set to "Return," then the control temperature parameter reads the same value as the Return Air parameter.
Occ Clg Spt	72.0°F	0.0- 100.0°F	Occ Clg Spt is an adjustable item which indicates the temperature in which the unit will go into the cooling mode of operation.
Occ Clg DB	2.0°F	0.0- 10.0°F	Occ Clg DB is an adjustable item which sets a dead band around the Occ Cooling Set Point parameter. For example, if the Occ Cooling Set Point parameter is set to 75°F and the Clg Deadband parameter is set to 2°F the dead band around the set point would be from 76.0°F to 74.0°F.
Disch Air	-	-50.0- 250.0°F	Disch Air is a status only item which displays the current temperature reading from the unit's discharge air temperature sensor (DAT). This sensor is standard on all units.
UseDATClgSpt	Yes	No Yes	UseDATClgSpt is an adjustable parameter that sets the DAT set point used during economizer. When set to Yes, the DAT cooling set point is used. When set to No, the DAT Econ Spt is used.
DAT Econ Spt	55.0°F	40.0- 100°F	DAT Econ Spt is an adjustable item which sets the DAT set point the cooling capacity is controlled to maintain when the UseDATClgSpt is set to No.
DAT Econ DB	2.0°F*	1.0- 10.0°F	DAT Econ DB is an adjustable item which sets the deadband around the DAT Econ Spt. If the disch air is within the DB no action is take. For example, if the discharge cooling set point is set to 55°F and the Clg DB is set to 2°F the dead band around the set point would be from 56.0°F to 54.0°F.
* 2.0°F when UseDATClgSpt= Yes 4.0°F when UseDATClgSpt= No			
Clg Stg Time	5 min	5-60min	Clg Stage Time is an adjustable item used to set a minimum time period between compressor stage changes.

Menu Display Name	Default	Range	Description
Econ Chgover	Energy	None OAT OAT RAT Energy	EconChangover is an adjustable item used to set the method that will be used to determine how economizer operation will be enabled.
OA Temp	-	-50.0- 200.0°F	OA Temp is a status only item which displays the current temperature reading from the unit mounted Outdoor air temperature sensor. This sensor is standard on all units.
Chngover Temp	70°F	-20.0- 120.0°F	Chngover Temp is a adjustable item that sets the maximum outdoor air temp at which economizer is allowed.
Econo Diff	2.0°F	0.0- 10.0°F	Econo Diff is an adjustable item which sets a differential above the ChngoverTemp parameter. Economizer operation is disabled when the OA Temp parameter indicates a value above the ChngoverTemp= parameter by more than this differential.
Econo FDD	On	Off On	Econo FDD is an adjustable item used to enable or disable the Economizer Fault Detection and Diagnostics function.
Econ Reset	None	None Network Space Return OAT	Clg Reset is an adjustable item that is used to set the type of cooling reset to be used.
Min Econ Spt	55.0°F	40.0- 100.0°F	Min Econ Spt is an adjustable item which sets the minimum cooling discharge set point for use with a economizer discharge air temperature set point reset schedule.
Min Econ Spt@	0	0-100/ NA °F °C mA V %	Min Econ Spt @ is an adjustable item which sets the value of the sensor input, selected with the Cooling Reset parameter, at which the DAT Econ set point parameter is reset to the minimum DAT Econ set point value.
Max Econ Spt	65.0°F	40.0- 100.0°F	Max Econ Spt is an adjustable item which sets the maximum economizer discharge set point for use with a economizer discharge air temperature set point reset schedule.
Max Econ Spt@	100	0-100/ NA °F °C mA V %	Max Econ Spt @ is an adjustable item which sets the value of the sensor input, selected with the Econ Reset parameter, at which the DAT Econ set point parameter is reset to the maximum DAT Econ set point value.
Max OAT Lmt	75°F	50.0- 100.0°F	Max OAT Lmt is an adjustable item which sets the maximum outdoor air temperature for the applicable climate zone above which economizer should not be enabled.
Min OAT Lmt	70°F	50.0- 100.0°F	Min OAT Lmt is an adjustable item which sets the minimum outdoor air temperature for the applicable climate zone below which economizer should be enabled.
Calibrate OAD	No	No Yes	Calibrate OAD is an adjustable item used to initiate the calibration function that captures the command position at which the outdoor damper position end switches open and close at the closed and open ends of the damper modulation range.
Pos Sw Open	97%	0-100%	PosSwOpen is an item that indicates the captured command position at which the outdoor damper position end switch closes at the open end of the damper modulation range. This parameter can also be manually adjusted.
Max Sw Diff	3%	0-100%	Max Sw Diff is an item that indicates the captured switch differential at the open (maximum) end of the damper modulation. This parameter can also be manually adjusted.

Menu Display Name	Default	Range	Description
Pos Sw Close	3%	0-100%	PosSwClose is an item that indicates the captured command position at which the outdoor damper position end switch closes at the closed end of the damper modulation range. This parameter can also be manually adjusted.
Min Sw Diff	5%	0-100%	Min SW Diff is an item that indicates the captured switch differential at the closed (minimum) end of the damper modulation. This parameter can also be manually adjusted.
OAD Sw Status	-	Open Closed	OAD Sw Status is a status only item that indicates the current condition of the damper end switch position input (Open/Closed).
OAEOffset	0.0°F	0.0- 10.0°F	OAEOffset is an adjustable item used to account for fan heat or for the discharge air temperature set point dew point calculation used to enable energy economizers.
OADewpoint	-	-50.0- 150.0°F	OADewpoint is a status only item that indicates the current calculated outdoor air dew point.
OARelHum	-	0-100%	OARelHum is a status only item that indicates the current outdoor air relative humidity reading.
OAEnthalpy	-	TBD BTU/lb	OAEnthalpy is a status only item that indicates the current calculated outdoor air enthalpy.
RADewpoint	-	-50.0- 150.0°F	RADewpoint is a status only item that indicates the current calculated return air dew point.
RARelHum	-	0-100%	RARelHum is a status only item that indicates the current return air relative humidity reading.
RAEnthalpy	-	TBD BTU/lb	RAEnthalpy is a status only item that indicates the current calculated return air enthalpy.
DATSptEnth	-	TBD BTU/lb	A status only item that indicates the current Discharge Air Temperature Enthalpy Set point.

## Energy Recovery

**Energy Recovery** is provided by drawing outside air across half of an energy recovery wheel and drawing exhaust air across the other half. Latent and sensible heat is transferred from the hotter, moister air stream, to the colder dryer air stream. In summer operation the direction of transfer is from the outdoor air to the exhaust air. In winter operation, the direction of transfer is from the warm exhaust air to the cold dry outdoor air. Control of the wheel consists of starting and stopping the wheel, and modulating the speed. The outdoor air dampers and supply and exhaust fans are controlled normally during wheel operation.

### Energy Wheel Operation

The energy recovery wheel is turned on whenever the unit is occupied, the exhaust fans are on, the OA dampers are at the minimum position, the unit is not in economizer, and the wheel has not been shut off due to frost prevention, Enthalpy override or capacity limiting control. Exhaust fans and outdoor air dampers are controlled to their normal states when equipped with energy recovery wheels.

- **Enthalpy Override:** During Cooling or Dehumidification operation, the MicroTech will evaluate if the energy wheel should be operating or if it is more energy efficient to bring outdoor air directly. Enthalpy override is decided by following the same cases as the energy economizer option except for case 4 where the LWT must less than the RAT. Review Energy Economizer for details. Enthalpy override is true when the Clg/DHERWOvrOff Flag is True. Once True this flag will be held true for at least the ERWStgTime before changing to false.
- **Heating Override:** During Heating, Fan Only, or MinDAT operation, if the energy recovery wheel heat transfer is in cooling, the wheel will shut off and the HtgERWOvrOff flag will be set to true. Once True, this flag will be held true for at least the ERWStgTime before changing to false.

### Energy Recovery Wheel Bypass

For units equipped with an **Energy Recovery Wheel** and a 0-100% modulating mixed air damper, a bypass damper may be provided for economizer operation or Enthalpy or Heating override conditions. During economizer, enthalpy override, and heating override operation, the energy wheel is turned Off and the bypass damper is opened to bypass the outside air around the energy wheel. This lowers the total air pressure drop and increases the effectiveness of economizer operation.

## Capacity Limiting

Energy wheel **Capacity Limiting** control is a means to limit the capacity of an energy wheel during part load conditions. Normally, wheels are sized for the worst case winter/summer load. Therefore, at part load the wheel may be oversized. Capacity limiting control is allowed when the energy recovery wheel leaving air temperature sensor is present and the outdoor air temperature is colder than the return air temperature.

- **Fan Only:** When the unit is in the Fan Only state, the energy recovery wheel is slowed do due to capacity limiting whenever the discharge air temperature (DAT) is above the MinDAT Limit set point by more than  $\frac{1}{2}$  the discharge air heating deadband. The wheel will modulate to maintain the DAT at the MinDAT Limit set point. FI the DAT falls back below the MinDAT Limit set point plus the  $\frac{1}{2}$  discharge heating deadband, the wheel will modulate back to full speed.
- **Heating:** When the unit is operating in the Heating state, the energy recovery wheel is slowed down due to capacity limiting whenever all heating is OFF and the discharge air temperature (DAT) is above the discharge heating set point by more than  $\frac{1}{2}$  the discharge air heating deadband. The wheel will modulate to maintain the heating discharge air set point when all other heating is OFF and capacity limiting is active. The wheel is modulated back to full speed when the DAT falls back to or below the discharge heating set point plus  $\frac{1}{2}$  the discharge air heating deadband.
- **Cooling:** When the unit is operating in the Cooling state, the energy recovery wheel is slowed down due to capacity limiting whenever all cooling is OFF and the discharge air temperature is below the discharge cooling set point by more than  $\frac{1}{2}$  the discharge air cooling deadband. The wheel will modulate to maintain the cooling discharge air set point when all other cooling is OFF and the capacity limiting is active. The wheel is modulated back to full speed when the DAT falls back to or above the discharge cooling set point plus  $\frac{1}{2}$  the discharge air cooling deadband.

## Energy Wheel Frost Prevention

Two different **Energy Wheel Frost Prevention** methods are provided depending on whether or not the unit is supplied with an electric preheat energy wheel defrost coil. When there is a threat of frost or condensation on the enthalpy wheel, a wheel with a electric preheat will be defrosted by modulating the electric preheat to raise the outdoor air temperature coming into the wheel to eliminate the frost potential. A variable speed wheel may be first slowed down, and then stopped so that less enthalpy transfer occurs and frosting or condensation on the energy wheel is avoided. In either case, the frost control action is based on a calculated psychrometric intersection point.

Condensation and frosting on the energy recovery wheel is possible when the exhaust air leaving the wheel is saturated. This condition is only possible when the energy recovery psychrometric saturation process line between the indoor and outdoor design points intersect the psychrometric saturation curve. The two ends of the energy recovery process line will be the outdoor air temperature at 95% relative humidity, and the return air temperature at the return air relative humidity. The process line examples shown below depict one process line that intersects the saturation curve, and one that does not. The one that does intersect does so at two points which indicates a potential for energy recovery wheel frosting. The higher of the two points is the intersection point that will be used by the frost prevention functions. The curve that does not intersect indicates no potential for frosting.

## Energy Wheel Frost Prevention Initiation

Condensation and frosting on the energy recovery wheel is possible when the exhaust air leaving the wheel is saturated. This condition is only possible when the energy recovery psychrometric saturation process line between the indoor and outdoor design points intersect the psychrometric saturation curve. The two ends of the energy recovery process line will be the outdoor air temperature at 95% relative humidity and the return air temperature at the return air relative humidity. The process line example shown below depicts one process line that intersects the saturation curve, and one that does not. The one that does intersect does so at two points, which indicates a potential for energy recovery wheel frosting. The higher of the two points is the intersection point that will be used by the frost prevention functions. The curve that does not intersect indicates no potential for frosting.

Figure 31: Frost Prevention Curve

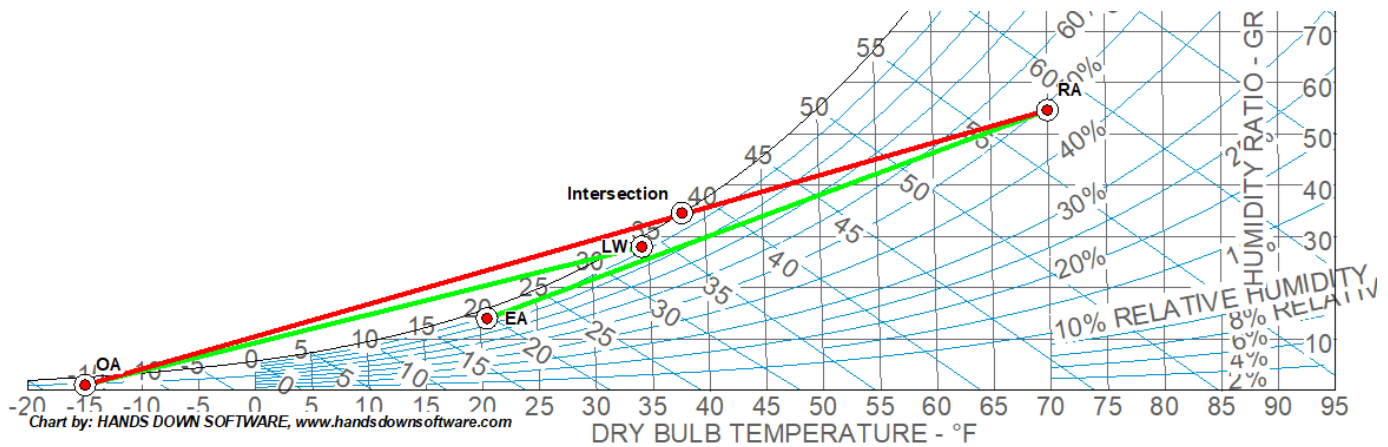

## Modulating Wheel Frost Prevention

**Modulating Wheel Frost Prevention** is initiated when the exhaust air temperature leaving the wheel is below the intersection point, plus an adjustable minimum temperature difference. In the example below, the Exhaust air (EA) is significantly below the intersection point.

During modulating wheel frost prevention, the wheel is controlled to its minimum wheel speed (default 15%) When the wheel is at its minimum speed, the wheel effectiveness is reduced. The resulting exhaust air temperature during frost prevention (EAF) is warmer than the intersection point and frost is prevented. The leaving wheel temperature (LWF) during frost prevention is also reduced.

**Figure 32: Modulating Wheel Frost Prevention Curve**

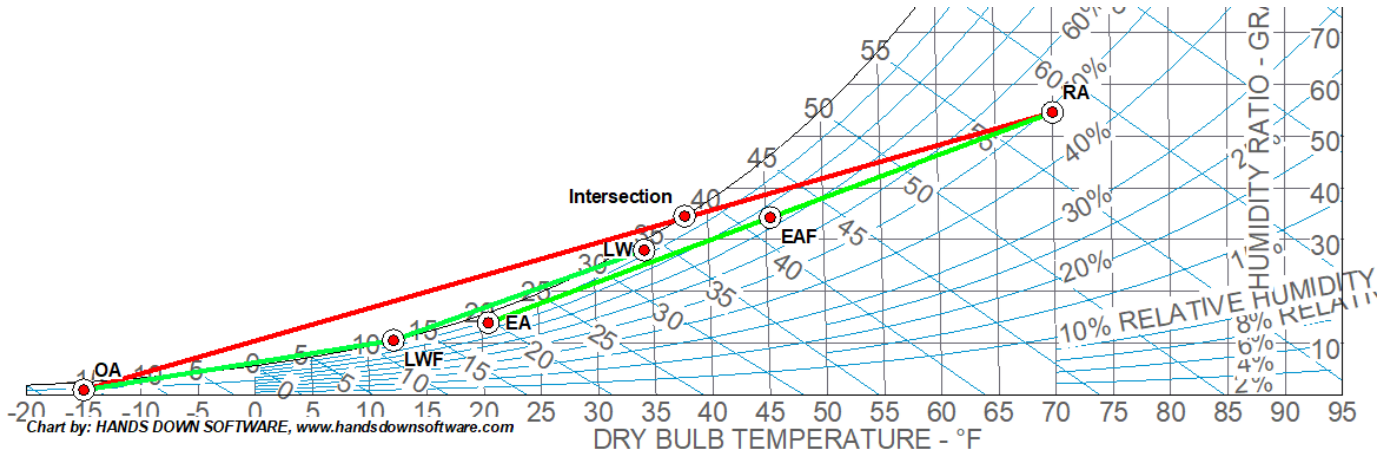

## Energy Recovery Wheel Commissioning

**Energy Recovery Wheel** units should come from the factory pre-programmed with the correct control requirements. There is nothing to commission during start up. The menu below displays energy recovery operating information. Advanced menu energy recovery options can be viewed in Table 100 on page 163.

**Table 33: Main Menu \ Commission Unit \ Energy Rec Set-Up**

Menu Display Name	Default	Range	Description
Energy Rec	Yes	No Yes	Energy Rec is an adjustable item which states if there is an energy recovery system or not.
ER Wheel	-	On Off	ER Wheel is a status only item used to indicate whether the energy recovery wheel is currently ON or OFF.
ER Whl Cap	-	0-100%	ER Wheel Cap is a status only item that displays the current wheel capacity/speed.
ER Whl CapCmd	-	0-100%	ER Wheel CapCmd is a status only item that displays the capacity the wheel is being commanded to operate at.
ER LWT	-	-50.0- 200.0°F	ER LWT is status only item which displays the current discharge air temperature leaving the optional energy recovery wheel.
ER EWT	-	-50.0- 200.0°F	ER EWT is a status only item which displays the current exhaust air temperature leaving the optional energy recovery wheel.
RARelHum	-	0-100%	RARelHum is a status only item that displays the current relative humidity of the return air Humidity sensor.

## Other Configurations

This Other Configurations section covers commissioning items and miscellaneous Rebel features.

### Timer Settings

The Timer Settings menu contains adjustable timers for various unit functions. This menu is also available in the Service menu (Main Menu \ Service Menu \ Timer Settings)

**Table 34: Main Menu \ Commission Unit \ Timer Settings**

Menu Display Name	Default	Range	Description
Start Up	180s	10-1800s	Startup is an adjustable item that sets the time in seconds that the unit will perform its startup operation.
Recirculate	180s	10-3600s	Recirculate is an adjustable item that sets the time in seconds that the unit operates with only the fan, recirculating the building air upon unit start up.
Clg Stg Time	5min	5-60min	Clg Stg Time is an adjustable item used to set a minimum time period between compressor stage changes.
Htg Stg Time	5min	2-60min	Htg Stg Time is an adjustable item used to set a minimum time period between heating stage changes.
Zero OA Time	0min	0-240min	Zero OA Time is an adjustable item that sets the time in minutes that the outdoor air damper stays at a zero position upon unit start up.
Tnt Ovr Incr	120min	0-300min	Tnt Ovr Incr is an adjustable item that sets the amount of time that the unit will go into operation when the tenant override function is activated. Tenant override can be activated by the space sensor button, the network occupancy mode parameter or the keypad Occ Mode= parameter.
Post Heat	0s	0-180s	Post Heat is an adjustable item that sets the duration of the post heat function available on VAV units.
Low DAT	6min	0-60min	Low DAT is an adjustable item that sets the duration of a time period upon unit start up during which the Low Discharge Temperature fault is ignored. This may be particularly important in colder climates when a unit has been off for a significant time period during which the unit, including the discharge air temperature sensor, has become very cold. This time period allows the unit to run long enough to turn the unit heat on and warm the discharge sensor above the alarm limit, preventing nuisance unit alarm shutdown. This time period begins when the supply fan starts.
Service Time	0min	0-60min	Service Time is an adjustable item that sets the amount of time the internal control timers can be temporarily sped up.



## Humidity Sensor Set-Up

The Humidity Sensor Set-Up menu is important to set up at commissioning, as it is critical to proper unit function. All humidity sensors that are connected and reliable are usable for temperature reset, and can be configured for use with dehumidification control. Dehumidification will control to maintain the source location of the sensors set for Hum Sensor1 and Hum Sensor 2. See "Dehumidification" on page 56 for details on dehumidification operation.

**Table 35: Main Menu \ Commission Unit \ Humidity Sensor Set-Up**

Menu Display Name	Default	Range	Description
Hum Sensor 1	SpaceH1	None SpaceH1 SpaceH2 RAH OAH	Hum Sensor 1 is an adjustable item used to set the location of sensor used for humidity set point 1. This humidity set point is configured to drive dehumidification in the Dehum Set-Up menu.
Hum Sensor 2	None	None SpaceH1 SpaceH2 RAH OAH	Hum Sensor 2 is an adjustable item used to set the location of sensor used for humidity set point 2. This humidity set point is configured to drive dehumidification in the Dehum Set-Up menu.
SpaceRH1Src	QMX1 if SpaceTCfg = QMX+1, QMX+2, QMX+3 Otherwise Analog	Analog QMX1 QMX3 IAQMB	SpaceRH1Src is an adjustable item that sets the type of sensor located at the Humidity Sensor 1 location.
SpaceRH2Src	QMX2	Analog QMX2 QMX3	SpaceRH2Src is an adjustable item that sets the type of sensor located at the Humidity Sensor 2 location.
SpcHumSensTyp	VDC	VDC mA	SpcHumSensType is an adjustable item that sets the signal type for when either the SpaceRH1Src and SpaceRH2Src is set to Analog.
SpcHum MinSig	0.0V	0.0-20.0 V/ mA	SpcHum MinSig is an adjustable item that sets the minimum of the signal range for when either the SpaceRH1Src and SpaceRH2Src is set to Analog.
SpcHum MaxSig	10.0V	0.0-20.0 V/ mA	SpcHum MaxSig is an adjustable item that sets the maximum of the signal range for when either the SpaceRH1Src and SpaceRH2Src is set to Analog.
SpaceRel Hum 1	-	0-100%	SpaceRel Hum 1 is a status only item that shows the current space relative humidity reading of space sensor 1.
SpaceDwpnt1	-	-50-150°F	SpaceDwpnt1 is a status only item that shows the current calculated space dew point of space sensor 1.
SpaceRel Hum2	-	0-100%	SpaceRel Hum 2 is a status only item that shows the current space relative humidity reading of space sensor 2.
SpaceDwpnt2	-	-50-150°F	SpaceDwpnt2 is a status only item that shows the current calculated space dew point of space sensor 2.
RARelHum	-	0-100%	RARel Hum is a status only item that shows the current relative humidity reading of Return air.
RADewpoint	-	-50-150°F	RADewpoint is a status only item that shows the current calculated dew point of the Rreturn air.
OARelHum	-	0-100%	OARel Hum is a status only item that shows the current relative humidity reading of Outdoor air.
OADewpoint	-	-50-150°F	OADewpoint is a status only item that shows the current calculated dew point of the Outdoor air.

## Remote Sensor Set-Up

When one or more network space sensors (up to three will be supported) are present, the sensors must be commissioned using the **Remote Sensor Set-Up** menu. Before network space sensors can be commissioned, the SpaceTCfg in the Unit Configuration Menu of the MicroTech must be set to QMXS1, QMXS2, QMXS3, QMX+1, QMX+2, or QMX+3. The QMXS# is a space temperature and set point adjust only sensor; the QMX+# is a Combo sensor with Temperature, adjustment, humidity, and CO2. For the unit to use the QMX+ Combo sensor for CO2 OA reset, the Unit configuration ExtOAInput must be set to CO2QMX+. The sensors will be identified by MicroTech based on a sensor ID number that is unique to each individual device. Write this number on the Box and on the sticker on each sensor. Write down the Room Zone name, and the ID (SN) for each room Zone Sensor. This will make it easier to name them during commissioning.

Room Zone 1: Name: \_\_\_\_\_  
Type: \_\_\_\_\_ ID: \_\_\_\_\_ h

Room Zone 2: Name: \_\_\_\_\_  
Type: \_\_\_\_\_ ID: \_\_\_\_\_ h

Room Zone 2: Name: \_\_\_\_\_  
Type: \_\_\_\_\_ ID: \_\_\_\_\_ h

## Set-Up and Commissioning Sensors

- Turn Unit Off:** The Unit State must be Off before the commissioning process can be activated and the unit will not be allowed to start while the commissioning process is active.
- Verify Unit Configuration:** Go To the Unit Configuration Menu: Main Menu \ Advanced Menu \ Unit Configuration Menu.
  - Verify the SpaceTCfg parameter matches the number and type of sensors you have.
  - Option 1 Temperature Only: (1)QMXS, (2) QMXS, or (3) QMXS. Sensor Model number/Type: QMX3.P34 or QMX3.P34-1WSB.
  - Option 2 Temperature/Humidity/CO2: (1)QMX+, (2) QMX+, or (3) QMX+. Sensor Model number/Type: QMX3.P74 or QMX3.P74-1WSB
  - Verify the ExtOAInput parameter matches the type and quantity of sensors.
  - ExtOAInput = CO2QMX+
  - CO2 capable network sensors you have. The QMX3.74 or QMX3.74-1WSB have CO2.
  - If any changes to the Unit Configuration were made you will need to "Apply Changes" on the Advanced Menus "Unit Configuration" Screen. The controller will reset.
- Verify the Unit Commissioning Set-Up:**
  - In the Unit Set-Up Menu, set the Eng Units= English or SI based on the application.
  - In the HtgClg ChgOver Set-up Menu, set Rem Spt Src = QMX1, QMX2 or QMX3 based on which sensor you

want to drive the set point.

- Name Each Sensor:** Name Each Enabled QMX Sensors Room Zone (As Applicable) Each enabled Sensor can be named to correspond to the particular Room Zone Location it is in (recommended). The Name is limited to 7 Alpha numeric characters.
    - Navigate: Commission Unit \ Remote Sensor Set-Up \ Snsr#:RoomZn# Info. The default name is RoomZn# where # is the sensor number.
    - While in the Snsr#:RoomZn# Info Screen change the associated name of Sensor# by selecting the Sensor#Name= RoomSn# and edit as desired. There is a max length of 7 alpha/numeric characters.
    - After editing the Room Zone Names of each sensor exit back to the Remote Sensor Set-Up Screen to initiate a Commissioning Sensor Sequence.
  - Commissioning QMX Sensors:**
    - Navigate: Main Menu \ Commission Unit \ Remote Sensor Set-Up
    - While in the Remote Sensor Set-Up Screen review the status (Valid/Invalid) of each Room Zone QMX Space Sensor and compare the ID(s) currently displaying on the HMI for each Sensor to the documented physical Sensor Room Zone ID(s) as denoted Above. Also inspect each sensor in its associated Room Zone location for proper IDs (as documented) and for proper operation and configured display. The configured display on each QMX Space Sensor should match the current "Unit Configuration".
    - Determine which, if any, Sensor(s) need to be commissioned. Note that if any Sensor currently has its "Status=Invalid" the QMX Space Sensor "Commission Procedure" needs to be performed prior to the QMX Space Sensor System being ready and usable for Space Control Operations. In order to initiate the Sensor(s) Commissioning Procedure the "Unit" must also be in the "Off State". If the "Unit" is not currently in the "Off State" proceed back to the Main "Daikin AHU" Menu Screen and put the "Unit" in the "Off State" when it is safe to do so and then proceed to the next step to initiate the "Commissioning Procedure" as desired.
    - Proceed to the next step to initiate the "QMX Room Zone Space Sensor Commission Process".
- NOTE:** Commissioning is required if any Room Zone Sensor is considered "Invalid" or if any of the currently displayed IDs for a Room Zone Sensor on the "Remote Sensor Set-Up" Screen does not match the documented ID(s) for those Sensor's Room Zone.
- Initiate the QMX Commissioning Process: In the "Remote Sensor Set-Up" Screen initiate the QMX Space Sensor(s) Commissioning Process by Selecting "CommissionMode=On". If there is not a current Sensor Fault preventing the "CommissionMode" from turning "On", the MicroTech Controller will automatically "re-start" after a short time delay of Commissioning Mode becoming "Active".
  - Main "Commissioning Active" (Chg&/orCnfrmIDs)

Screen: (Once the controller re-starts proceed to the Main Commissioning Active “Chg&/orCnfrmIDs” Menu Screen when prompted to do so on the HMI. The status of the commissioning process should be on the HMI:

- “Commission Sts=Active”
- “CommissionMode=On”
- “ConfirmSnsrIDs=No”

**NOTE:** If there was a Sensor “Alarm” upon restart of the controller the commissioning mode sequence will reset to “Off”, with the controller re-starting after a short time delay. The “Alarm” will need to be remedied prior to re-initiating the “Commissioning Process”

- Reset a Room Zone QMX Space Sensor Status to “Invalid”: Only Sensor(s) with a “SensorX Status=Invalid” will go thru the “Commissioning Process”. So, if you want a “Valid” QMX Space Sensor to go thru the “Commissioning Process” it will need to have its status reset to “Invalid” first.

- Go to the “Reset Sensors” Screen to reset Sensor(s) status from “Valid” to “Invalid” as required.

**NOTE:** This is not a typical step you will have to perform and is only needed if you suspect or denote that a particular Room Zone Sensor that has its “Status=Valid” is not configured or working properly.

- Change (Update) a Room Zone QMX Space Sensor(s) ID: To change a Room Zone Sensor’s ID currently displaying on the HMI that does not match the ID of the documented Sensor located in that Room Zone proceed to the “Chg Sensor IDs” Menu Screen. Then go to the corresponding “SnsrX:’RoomZnX’ ID Chg” Screen and update the ID of the selected Sensor accordingly.

**NOTE:** You can only change the ID of a Sensor that currently has its “SensorX Status=Invalid”.

- Confirm Displayed Sensor(s) IDs are Correct: Once the desired Sensor(s) to be “Commissioned” have an “Invalid” Status and the displayed IDs for each Room Zone Sensor on the Main Commissioning Active “Chg&/orCnfrmIDs” Screen match the documented IDs of the Sensors physically located in those Room Zones, initiate the “Confirm Space Sensor IDs” Step by setting “ConfirmSnsrIDs=Yes”. After a short time delay the Controller will “reset”.

**NOTE:** If the “Commissioning Mode” is manually turned “Off” while it is “Active, the controller will re-start after a short time delay and have to be re-initiated from step 1

- Main “Commissioning Active” (Config Sensors) Screen: Once the controller re-starts proceed back to the Main Commissioning Active “Config Sensors” Menu Screen when prompted to do so on the HMI. The Sensor(s) “Reset” and “ID Change” Functions are disabled once the “ConfirmSnsrIDs=Done”.

If the confirm process was successful, the status of the commissioning process should be on the HMI:

- “Commission Sts=Active”
- “CommissionMode=On”
- “ConfirmSnsrIDs=Done”
- “Config Sensors=Off”

**NOTE:** If there was a Sensor “Alarm” upon restart of the controller the commissioning mode sequence will reset to “Off”, with the controller re-starting after a short time delay. The “Alarm” will need to be remedied prior to re-initiating the “Commissioning Process” from step 4.5.1.

- Initiate the QMX Space Sensor(s) Assignment & Configuration Phase: To Initiate the “Assignment & Configuration” Phases of the Sensor(s) “Commissioning Process” for each “Invalid” Sensor, set “Config Sensors=Execute”. This will initiate each “Invalid” sensor’s assignment and configuration steps. When the process has successfully started “Config Sensors=Active” on the HMI.

- QMX Space Sensor(s) Assignment & Configuration Phases are In-Process: Monitor the “SensorX State=” displays on the HMI. The State of each Sensor going thru the “Commissioning Process” should go from “OK” to “Init” and back to “OK” when it has completed the “assignment” step. When the “assignment” phase for all of the sensor(s) has successfully completed the “Configuration” phase for those sensor(s) will begin. For each Sensor going thru the “Commissioning Process” the State of that Sensor will go from “OK” to “Config” and back to “OK” as the configuration phase of each sensor proceeds and completes. Each Sensor’s status will transition from “Invalid” to “Valid” as its “Commissioning Process” is completed.

**NOTE:** If there is an “Alarm”, or Commissioning Mode is turned “Off” during this step, the commissioning sequence will reset to “Off and will have to be re-initiated from Step 1.

- QMX Space Sensor(s) Commissioning Complete: Once each QMX Space Sensor’s Commissioning Process is complete its status will go from “Invalid” to “Valid”. When all of the Sensor status’s are “Valid” and their respective State(s) are back to “OK”, the “Commissioning Mode will turn “Off” and the controller will reset one final time after a short time delay to complete the commissioning process.

- Once the controller re-starts the QMX Space Sensor(s) Commissioning Process is Complete. With “CommissionMode=Off” after the controller re-start, you will now be able to proceed back to the Main “Daikin AHU” Menu Screen when pressing the back button on the HMI when prompted to.

**6. Verify that the Remote Sensor (s) are Configured and Working Properly:** Once the “Commissioning Process” of the Room Zone Sensor(s) is complete, proceed back to the “Remote Sensor Set-Up” Screen. All of the Enabled Sensors should be displayed with a “non-zero” ID and all should have a “Valid” status. Make sure after the long initialization and start-up delay that the “AllSnsrsReady=Yes”. Once “AllSnsrsReady=Yes” go to each individual Sensor’s Room Zone information screen (located towards the bottom of the “Remote Sensor Set-Up” Menu Screen) and verify that the “Relative Humidity, CO2, and/or Temperature” values being displayed on the QMX Space Sensor’s display are correct for the Sensor(s) physically located in those rooms and are correctly being transmitted back to and displayed on the MicroTech Controller HMI.

**Table 36: Main Menu \ Commission Unit \ Remote Sensor Set-Up**

Menu Display Name	Default	Range	Description
Snsr1 ID	-	000000000000-fffffffffffh	Snsr1 ID = “.....h” is a status only item that indicates the current remote sensor ID connected as “Sensor1” (RoomZn1).
Snsr2 ID	-	000000000000-fffffffffffh	Snsr2 ID = “.....h” is a status only item that indicates the current remote sensor ID connected as “Sensor2” (RoomZn2).
Snsr3 ID	-	000000000000-fffffffffffh	Snsr3 ID = “.....h” is a status only item that indicates the current remote sensor ID connected as “Sensor3” (RoomZn3).
Commission Sts	-	Inactive Active	Commission Sts is a status only item that Indicates current status of commission mode. “Active” means sensor commissioning mode is in process.
CommissionMode	Off	Off On	CommissionMode is an adjustable item that allows you to turn “Commission Mode” On or Off. Turn “Commission Mode” to “On” to initiate the Remote Networked Sensor(s) Commissioning Mode that defines the Sensor ID assigned to each configured Room Zone and the type of QMX Sensor they are. Turn “Commission Mode” to “Off” to disable currently “Active” Commissioning Mode. Controller will perform a “reset” upon turning “Commissioning Mode “Off”.
AllSnsrsReady	-	No Yes	AllSnsrsRady is a status only item that Indicates whether all of the system Networked Remote QMX Sensors are configured and ready to operate or not. A status of “Yes” indicates all remote sensors on the network are properly configured and are ready for operation with valid values. A status of “No” indicates one or more of the remote sensors are not configured, commissioned, or ready for operation yet.
Sensor1Sts	-	Invalid Valid	Sensor1Sts is a status only item that Indicates whether the Remote QMX Space Sensor assigned to Sensor1 (RoomZn1) on the network is currently considered “Valid” (Commissioned) or “Invalid” (Commissioning Required). A “Valid” Sensor has been assigned, is Configured correctly, and is communicating with the controller properly with the assigned ID for that sensor.
Sensor2Sts	-	Invalid Valid	Sensor2Sts is a status only item that Indicates whether the Remote QMX Space Sensor assigned to Sensor2 (RoomZn2) on the network is currently considered “Valid” (Commissioned) or “Invalid” (Commissioning Required). A “Valid” Sensor has been assigned, is Configured correctly, and is communicating with the controller properly with the assigned ID for that sensor.
Sensor3Sts	-	Invalid Valid	Sensor3Sts is a status only tem that Indicates whether the Remote QMX Space Sensor assigned to Sensor3 (RoomZn3) on the network is currently considered “Valid” (Commissioned) or “Invalid” (Commissioning Required). A “Valid” Sensor has been assigned, is Configured correctly, and is communicating with the controller properly with the assigned ID for that sensor.

Menu Display Name	Default	Range	Description
Sensor1 State, Sensor2 State, Sensor3 State	-	OK Init DAA Absence Config Error	<p>Sensor1,2,3 State is a status only item that indicates the current state of the remote QMX Sensor.</p> <p>(0) "OK" – Indicates any given Device Command has finished successfully and the sensor with the assigned ID for this Room Zone is communicating properly with the C600 Controller.</p> <p>(1) "Init" – Indicates a sensor initialization is in process or is needed. An initialization is done for each PL-Link Device on the network when the controller is re-starting. If a given sensor state stays in "Init" indefinitely it is an indication that there is no sensor attached to the network with the given sensor ID or an incorrect sensor is attached to the network for that Room Zone.</p> <p>(2) "DAA" – Indicates a Device Command to assign an address to a network remote QMX sensor is in process.</p> <p>(3) "Absence" – Indicates that the Sensor with the assigned sensor ID for this Room Zone has not been detected on the PL-Link network by the ProcessBus Communications for a length of time. If the sensor with the assigned ID for the Room Zone is detected again on the network before a communications fault has occurred the system and sensor ready status can return to normal "Valid – OK" status.</p> <p>(4) "Config" – The remote QMX Sensor with the given room zone ID is currently being configured with all of the properties and parameters in the configuration XML file being downloaded to it.</p> <p>(5) "Error" – Indicates that the QMX Sensor with the given room zone ID is currently faulted.</p>
Sensor1:RmZn1	Menu	0.0-150°F	Select this to access additional information for Sensor1 "RoomZn1". The default room name for Sensor1 is within the parenthesis "RoomZn1". The name of Sensor1 within the ".." can be changed on the "Snsr1 Information" Screen. The "name" is limited to 7 characters.
Sensor2:RmZn2	Menu	0.0-150°F	Select this to access additional information for Sensor2 "RoomZn2". The default room name for Sensor2 is within the parenthesis "RoomZn2". The name of Sensor1 within the ".." can be changed on the "Snsr2 Information" Screen. The "name" is limited to 7 characters.
Sensor3:RmZn3	Menu	0.0-150°F	Select this to access additional information for Sensor3 "RoomZn3". The default room name for Sensor3 is within the parenthesis "RoomZn3". The name of Sensor3 within the ".." can be changed on the "Snsr3 Information" Screen. The "name" is limited to 7 characters.

Table 37: Main Menu \ Commission Unit \ Snsr1:RmZn1, 2, or 3

Menu Display Name	Default	Range	Description
Sensor1 Name	RoomZn1	***** (7 character name)	This is a text input for defining the name of the Room Zone associated with "SensorX". It is limited to 7 characters. Upper Case, Lower Case, and Numbers are allowed.
Rem Space T	-	-0.0-150°F	Actual "Temperature" value detected by SensorX in that space.
Rem Space CO2	-	0-5000ppm	Actual "CO2" concentration value detected by SensorX in that space.
Rem Space RH	-	0-100%	Actual "Relative Humidity" value detected by SensorX in that space.
Rem Space Spt	-	50.0-86.0°F	Space Temperature Set point. This set point may or may not be adjustable via the Remote QMX SensorX in the Space. That depends on the Remote Set point Source.
Rem Occupancy	-	UnOcc Occ	This displays the current occupancy of the space. The Occupancy can be put into Tenant Override Occupancy locally at the Remote QMX Space Sensor by using the Local Tenant Override on the QMX Space Sensor. The Sensor will also display whether the Space is currently in Occupancy or not. Pressing the Tenant Override button on the QMX Space Sensor, while the Space is already Occupied in Tenant Override, will reset the Tenant Override time back to its starting default value and re-start time down.
Snsr1 ID	-	000000000000-fffffffffh	This displays the current ID(SN) assigned for SensorX for this Room Zone. The SensorX "ID" on the physical sensor in this Room Zone must match this value or the sensor and C600 Controller will not communicate or transmit data properly. If the display shows "00000000000h"s then the Sensor ID assignment for this Room Zone is unknown. In this case the sensor is not present on the network, it is in alarm, a different sensor ID is attached to this room zone, a wrong type of sensor is in this room zone, or the sensor for this room zone has yet to be commissioned. In any case, if this displays "0...0h" then the physical wiring and operation of the sensor in this Room Zone must be verified and the Sensor Commissioning Procedure Performed. Initially when Sensor Commissioning is started the Sensor ID shown here could be incorrect to what is physically in this Room Zone if more than one sensor is on the network.
Sensor 1 Addr	-	000-999	This displays the actual "KNX" address of this device on the PL-Link Network. It is only valid when the "SnsrX ID" above has a valid 13 character ID and the sensor has been Commissioned.
Snsr1 Alm Sts	-	OK Fault	This displays the current Alarm Status of this Sensor.
Sensor1 Cmd	-	OK Init AddrPMode AddrSnr Auto Config AssignPMode	This indicates the current "Cmd" the C600 Controller is issuing to the currently Assigned QMX Sensor for this Room Zone on the KNX PL-Link Network. A value of "OK" means that no current command is in process. A value of "Init" means that Sensor is in an "initialization" command state on the network. Note that the "Init" command happens automatically when the controller starts. A value of "Config" means that this sensor is in the process of being configured. Note that "AddrPMode/AddrSnr/AssignPMode" are not used for the QMX Sensor Device use on the PL-Link Network in this application.
Sensor1 State	-	OK Init DAA Absence Config Error	This indicates the current state of the QMX SensorX for this Room Zone. See Section 2.2 for detailed description of each possible state.

Menu Display Name	Default	Range	Description
Snsr1 Rdy Sts	-	No Yes	This indicates that the remote QMX Space Sensor for this Room Zone is commissioned, "Valid", communicating properly, and is ready for operation on the KNX PL-Link Network.
ID Assign Done	-	No Yes	This indicates if this particular QMX Space Sensor's Room Zone Network Assign Address Step of the Commissioning Process is complete or not. Note that this possibly can indicate whether this sensor is causing the "SnsrX Rdy Sts" and/or "AllSnsrReady" Display Status to not indicate "Yes".
Config Done	-	No Yes	This indicates if this particular QMX Space Sensor Configuration Step of the Commissioning Process is complete or not. Note that this possibly can indicate whether this sensor is causing the "SnsrX Rdy Sts" and/or "AllSnsrReady" Display Status to not indicate "Yes".

## Configurable I/O

A MicroTech can be equipped with a field configurable I/O Module which allows for field added sensors or inputs and Outputs to be read by the MicroTech and displayed to the Building Automation System. Outputs can be written through the BAS to a third party device. Outputs can be analog 0-10V or 0-20.0mA and can be used to modulate field/BAS controlled devices.

**Table 38: Main Menu \ Commission Unit \ Configurable I/O**

Menu Display Name	Default	Range	Description
ApplyIOChgs	No	No Yes	ApplyIOChgs is a adjustable item that configures the IO when changes are made to the X1—X8 Cfg or the input ranges.
X1...X8 Cfg	AI_V	DI AI_V AI_mA NTC10k AO_V AO_mA	X1...X8 Cfg is an adjustable item that configures the IO type that will be used at that input or out on the expansion module. There are 8 configurable IO on the I/O Module.
Input X1...X8 DI	-	Open Close	Input X1...X8 DI is a status only item of the current digital input device.
Input X1...X8 AI	-	0-10.0V	Input X1...X8 AI is a status only item that shows the current analog input voltage.
Input X1...X8 AI	-	4-20.0mA	Input X1...X8 AI is a status only item that shows the current analog input mA.
Input X1...X8 Temp	-	-50-250°F	Input X1...X8 Temp is the status only item that shows the current temperature reading of the input.
Output X1...X8 AO	-	0-10.0V	Output X1...X8 AO is a status only item that shows the current analog output voltage at this output.
Output X1...X8 AO	-	0-20.0mA	Output X1...X8 AO is a status only item that shows the current analog output mA at this output.
Output DO1-DO6	-	Off On	A status only item that shows the current state of the digital output.

## Trending Set-Up

The MicroTech ships from the factory with four pre-configured Trend Sets and one freely definable trend set. One or all of these sets may be activated at anytime. Trend Set 1 will come from the factory configured to trend. Each trend set contains up to 30 data points. The data collected may be manually or automatically exported to an SD card (factory provided) inserted into the controllers built in SD card reader. All of the defined points in all activated trend sets will be trended as one group when the TrendOnOff automation object is set to On. The trending method will be fixed as a cyclic trend with an adjustable CycleTime.

**Table 39: Trend Set 1 Names and Descriptions**

Trend Set 1		
Point #	Point Name	Description
1	UnitState	Unit State
2	ClgCapacity	Cooling Capacity
3	HtgCapacity	Heating Capacity
4	ReheatCapacity	Reheat Capacity
5	OAdmprOut	Outdoor Air Damper Position
6	MinOASrc	Minimum Outdoor Air Source
7	SAFCapOut	Supply Fan Capacity Command
8	SAFCapFbk	Supply Fan Capacity Feedback
9	SAFDSP	Duct Static Pressure
10	EFCapOut	Exhaust Fan Command
11	EFCapFbk	Exhaust Fan Capacity Feedback
12	BSP	Building Static Pressure
13	UnitStatus	Unit Status
14	ClgStatus	Cooling Status
15	DehumStatus	Dehumidification Status
16	EconStatus	Economizer Status
17	HtgStatus	Heating Status
18	ControlTemp	Control Temperature
19	CtrlTempSrc	Control Temperature Source
20	DAT	Discharge Air Temperature
21	RAT	Return Air Temperature
22	EffOAT	Outdoor Air Temperature
23	SpaceTemp1	Space Temperature 1
24	SpaceTemp2	Space Temperature 2
25	SpaceTemp3	Space Temperature 3
26	EFT_LCT	Entering Fan/Leaving Cooling Coil Temperature
27	ActiveAlarmEnum	Current Alarm Enumeration
28	CurrentClgStg	Current Cooling Stage
29	CurrentHtgStg	Current Heating Stage



**Table 40: Trend Set 2 Names and Descriptions**

Trend Set 2		
Point #	Point Name	Description
1	AirFlwStatus	Airflow Status
2	OccSrc	Occupancy Source
3	UnoccSrc	Unoccupied Source
4	OccClgSpt	Occupied Cooling Set point
5	OccHtgSpt	Occupied Heating Set point
6	DATClgSetpoint	Discharge Air Temperature Cooling Set point
7	DATHtgSetpoint	Discharge Air Temperature Heating Set point
8	MinOAPos	Effective Minimum Outdoor Air Position
9	OAFflow	Outdoor Airflow
10	OAFflowSpt	Outdoor Airflow Set point
11	PPM	Carbon Dioxide
12	RemEFCap	Remote Exhaust Air Fan Capacity
13	RemSAFCap	Remote Supply Air Fan Capacity
14	VFDAnlg_EFStatus	Supply Fan Drive Status (EFTYPE=RFAnalog or EFAnalog)
	VFD_EFStatus	Supply Fan Drive Status (EFTYPE=EFVFDMB(ABB))
	ECM_EF1Status	Exhaust Fan Drive Status
15	EF1CommStatus	Exhaust Fan Communication Status
16	VFDAnlg_SAFStatus	Supply Fan Drive Status
	VFD_SAFStatus	Supply Fan Drive Status
	ECM_SAF1Status	Supply Fan 1 Drive Status
17	SAF1CommStatus	Supply Air Fan 1 Communication Status
18	EconChgOvr	Economizer Changeover Method Status
19	FanInterlock	Supply Fan Interlock Input Status
20	EPSP	Exhaust Plenum Static Pressure

**Table 41: Trend Set 3 Names and Descriptions**

Trend Set 3		
Point #	Point Name	Description
1	ERWhlCapOut	Energy Recovery Wheel Capacity
2	ER_EWT	Energy Recovery Wheel Exhaust Air Temperature
3	ER_LWT	Energy Recovery Wheel Leaving Air Temperature
4	Hum_1	Relative Humidity Input 1
5	Hum_2	Relative Humidity Input 2
6	Hum1Spt	Relative Humidity Set point 1
7	Hum2Spt	Relative Humidity Set point 2
8	ReheatSpt	Reheat Set point
9	Dewpoint1	Calculated Dew point Input 1
10	Dewpoint2	Calculated Dew point Input 2
11	Dewpnt1Spt	Dew point 1 Set point
12	Dewpnt2Spt	Dew point 2 Set point
13	SpaceRelHum1	Space Relative Humidity Sensor 1
14	SpaceRelHum2	Space Relative Humidity Sensor 2
15	OARelHum	Outdoor Air Relative Humidity Sensor
16	RARelHum	Return Air Relative Humidity Sensor
17	SpaceDewpoint1	Calculated Dew point Space Input 1
18	SpaceDewpoint2	Calculated Dew point Space Input 2
19	OADewpoint	Calculated Outdoor Air Dew point
20	RADewpoint	Calculated Return Air Dew point
	EffHeatCoolIn	Refrigeration Only Control Effective Heat Cool Input
21	CmpCapOut	Refrigeration Only Control Compressor Capacity Out
22	EffCmpCapIn	Refrigeration Only Control Effective Compressor Capacity Command Input
23	EffRhtVlvIn	Refrigeration Only Control Effective Reheat Capacity Command Input
24	EffCmplInterlock	Refrigeration Only Control Effective Compressor Interlock Input
25	LocRemStatus	Refrigeration Only Control System Mode Status Output
26	AlarmReset	Refrigeration Only Control Alarm Reset Input
27	EffSAFCapIn	Refrigeration Only Control Effective Supply Fan Capacity Input
28	EffEFCapIn	Refrigeration Only Control Effective Exhaust Fan Capacity Input
29	PrhtVlvOut	Preheat Heating Valve On/Off Output
30	PreheatCap	Preheat Capacity

**Table 42: Trend Set 4 Names and Descriptions**

Trend Set 4		
Point #	Point Name	Description
1	PTS1	Suction Refrigerant Pressure Circuit 1
2	PTD1	Discharge Refrigerant Pressure Circuit 1
3	C1DRT1	Discharge Refrigerant Temperature Circuit 1
4	DSH1	Discharge Superheat Circuit 1
5	Subcooling1	Subcooling Circuit 1
6	VCmp1CommSts	Variable Compressor 1 Compressor Status
7	VCmp1RpsOut	Variable Compressor 1 Command Output
8	VCmp1HMICapOut	Variable Compressor 1 Capacity Output
9	VCmp1SSOut	Variable Compressor 1 Start/Stop Output
11	LCTSetpoint	Leaving coil set point
	LCTSptSCRRht	Leaving coil set point
12	SAFFlow	Supply Air Fan Airflow
13	EFFlow	Exhaust Air Fan Airflow
14	HtgCapCmd	Heating Capacity Command Input
15	Spare	
16	Spare	

**Table 43: Trend Set 5 Names and Descriptions**

Trend Set 5		
Point #	Point Name	Description
1	C1OAF1Status	Circuit 1 Outdoor Fan 1 Status
2	C1OAF2Status	Circuit 1 Outdoor Fan 2 Status
3	CurrCmpHtgStg	Current Compressor Heating Stage
4	C1EVICapOut	Circuit 1 EVI Capacity Output Command
5	C1EVOCapOut	Circuit 1 EVO Capacity Output Command
6	Spare	
7	Spare	
8	Spare	
9	Spare	

## Trending Set-Up Menu

Table 44: Main Menu \ Trending Set-Up

Menu Display Name	Default	Range	Description
Apply Chgs	No	No Yes	Apply Chgs is an adjustable item used to reset the controller when changes to the trending have been made. This flag must be set to yes for changes in this menu to become active.
Sample Time	60s	1-3600s	Sample Time is an adjustable item that sets how frequently trended data points are collected and recorded.
TrendOnOff	Off	Off On	TrendOnOff is an adjustable item that sets if trending is active or not.
Enable Trend 1	Yes	No Yes	Enable Trend 1 is an adjustable item that sets if Trend set 1 is being recorded or not.
Enable Trend 2	No	No Yes	Enable Trend 2 is an adjustable item that sets if Trend set 2 is being recorded or not.
Enable Trend 3	No	No Yes	Enable Trend 3 is an adjustable item that sets if Trend set 3 is being recorded or not.
Enable Trend 4	No	No Yes	Enable Trend 4 is an adjustable item that sets if Trend set 4 is being recorded or not.
Enable Trend 5	No	No Yes	Enable Trend 5 is an adjustable item that sets if Trend set 5 is being recorded or not.
Ena Free Trend	No	No Yes	Ena Free Trend is an adjustable item that allows the user to select up to 30 of their own trend points using the Free Trend Points menu.
AutoExpTime	1440min	0-1440min	AutoExpTime is an adjustable item that sets the time interval that all accumulated trend data in the controller is exported to the SD card. The default value of 1440 means the data would transfer once a day at 11:59 PM. When the AutoExp Time is set to any value less than 1440 all the accumulated trend data in the controller will be exported to the SD card at intervals equal to that value.
Export Data	No	No Yes	Export Data is an adjustable item that initiates an export of all currently accumulated trend data. When ExportData is set to Yes, all the accumulated trend data in the controller will be exported to the SD card. ExportData will automatically revert to No when export is complete.
Clear Trend	Done	Done ClrData ClrCfg	ClearTrend is an adjustable item that is used to clear the Trend Archive Memory. ClrData will delete all the data and the trend set-up will remain. When ClrCfg is used the trend memory will be completely erased including all of the data.
TrendFull	Wrap	Wrap Stop	TrendFull is an adjustable item that is used to determine if the data should overwrite the oldest data on the card when the memory is full "Wrap", or if it should stop trending when the memory is full.

## BMS Communications

Refer to the installation manuals below for detailed instructions for each BMS communication type.

- IM 916 MicroTech Unit Controller – BACnet IP
- IM 917 MicroTech Unit Controller – BACnet MSTP
- IM 918 MicroTech Unit Controller – LON Communications

## LON Set-Up

**Table 45: Main Menu \ BMS Communications \ LON Set-Up**

Menu Display Name	Default	Range	Description
Neuron ID	-	-	Neuron ID is a status only item that indicates the Neuron ID of the LonWorks communication module. The Neuron ID field displays zeros and does not populate until the communication module has been commissioned.
Snd Hrt Bt	60s	0-6553s	Send Heartbeat.
Rcv Hrt Bt	0s	0-6553s	Receive Heartbeat. Defines the maximum time that elapses after the last update to a specified network variable input before the unit starts to use default values. nclRCvHrBt can also be used to change these values.
Min Snd Tm	0s	0-6553s	Minimum Send Time. Controls the minimum period of time that expires before certain network variables are transmitted. nclMinSendTime can also be used to change these values.
Comm Status	-	OK(0) Hardware(1) Init(2) Memory(3) ID(4) COVReg(5) Other (6)	Comm Status shows the status of the communications.
LON BSP	-	-	Board Support Package. Displays the version of firmware loaded in the LonWorks communication module.
Lon App Ver	-	-	LonWorks application version. Displays the version of the chiller software application loaded in the LonWorks communication module. This parameter remains blank until the communication module is commissioned.

## BACnet MSTP Set-Up

Table 46: Main Menu \ BMS Communications \ BACnet MSTP Set-Up

Menu Display Name	Default	Range	Description
ApplyMSTPChgs	No	No Yes	ApplyMSTPChgs is an adjustable flag that when set to yes will cycle power to the controller to allow the network setup changes to take place.
Name	-	-	Up to a 17 Character Device Object Name. Change this value as needed to match installation parameters.
Dev Instance	-	0-4194302	Device Instance of the BACnet communication module.
MSTP Address	-	0-127	This is the MST/TP address of the BACnet communication module.
Baud Rate	38400	9600 19200 38400 76800	Baud Rate is an adjustable item that is the Data Transfer speed.
Max Master	127	1-127	Max Master is an adjustable item that specifies the highest possible address for master nodes and shall be less than or equal to 127.
Max Info Frm	10	1-32	Max Info Frm is an adjustable item that specifies the maximum number of information frames the BACnet communication module may send before it must pass the token.
Unit Support	English	SI English	Unit Support is an adjustable item that sets the types of units passed through BACnet. (English or Metric).
Term Resistor	No	No Yes	Term Resistor is an adjustable item that be set to yes – no.
NC Dec 1	0	0-4194302	NC Dev 1 is an adjustable item that sets the device instance of the BACnet workstation or device that will receive the alarm notifications.
NC Dev 2	0	0-4194302	NC Dev 2 is an adjustable item that sets the device instance of the BACnet workstation or device that will receive the alarm notifications.
Comm Status	-	OK(0) Hardware(1) Init(2) Memory(3) ID(4) COVReg(5) Other (6)	Comm Status shows the status of the communications.
BACnet BSP	-	-	Board Support Package. Displays the version of firmware loaded in the LonWorks communication module.

## BACnet IP Set-UP

Table 47: Main Menu \ BMS Communications \ BACnet IP Set-Up

Menu Display Name	Default	Range	Description
ApplyIPChgs	No	No Yes	ApplyIPChgs is an adjustable flag that when set to yes will cycle power to the controller to allow the network setup changes to take place.
Name	-	-	Up to a 17 Character Device Object Name. Change this value as needed to match installation parameters.
Dev Instance	-	0-4194302	Device Instance of the BACnet communication module.
UDP Port	47808	0-65535	UDP Port is the User Datagram Protocol. The UDP Port allows host to host communication via the IP network and is used to identify the application process in the destination unit. Only change the UDP Port if there are multiple subnets. See a network administrator before modification.
DHCP	On	On Off	DHCP is the Dynamic Host Configuration Protocol. The DHCP is a network protocol that enables a server to automatically assign an IP Address. Set to Off if a static IP address is needed.
Act IP	0.0.0.0	-	Act IP Is the Actual IP Address of the BACnet Communication module.
ActMsk	0.0.0.0	-	ActMsk is the actual Subnet Mask of the BACnet Communication Module.
ActGwy	-	-	ActGwy is the actual gateway address.
Gvn IP	127.0.0.1	-	Gvn IP is the Given IP Address of the BACnet Communication Module.
GvnMsk	255.255.255.0	-	Gvn Msk is the Given Subnet Mask of the BACnet Communication Module.
GvnGwy	127.0.0.1	-	GvnGwy is the Given Gateway address of the BACnet Communication Module.
Unit Support	English	SI English	Unit Support is an adjustable item that sets the types of units passed through BACnet. (English or Metric)
NC Dec 1	0	0	NC Dev 1 is an adjustable item that sets the device instance of the BACnet workstation or device that will receive the alarm notifications.
NC Dev 2	0	0	NC Dev 2 is an adjustable item that sets the device instance of the BACnet workstation or device that will receive the alarm notifications.
EnaWebSrvr	Off	Off On	EnaWebSrvr is a flag to enable the web server.
Comm Status	-	OK(0) Hardware(1) Init(2) Memory(3) ID(4) COVReg(5) Other (6)	Comm Status shows the status of the communications.
BACnet BSP	-	-	Board Support Package. Displays the version of firmware loaded in the LonWorks communication module.



## Network Unit Set-Up

Table 48: Main Menu \ BMS Communications \ Network Unit Set-Up

Menu Display Name	Default	Range
Ctrl Mode	Off	Off HeatOnly CoolOnly FanOnly HeatCool Auto/Net
Occ Mode	Auto/Net	Occ Unocc TntOvrd Auto/Net
Clg Reset	None	None Network Space Return OAT ExtmA ExtV Airflow SpaceH1 SpaceH2 OAH RAH
Econo Reset	None	None Network Space Return OAT
Htg Reset	None	None Network Space Return OAT ExtmA ExtV
Min OA Reset	None	None Network ExtSig
Ctrl Temp Src	RAT	RAT Space OAT None

Menu Display Name	Default	Range
Rem Spt Src	None	None AI QMX1 QMX2 QMX3
Occ Clg Spt	72.0°F	0.0-100.0°F
Occ Htg Spt	68.0°F	0.0-100.0°F
SAF Ctrl	CAV	DSP Spd/Net 1ZnVAV BSP CO2 Flow CAV
EF Ctrl	BSP	CAV BSP Tracking DSP Spd/Net Flow OAD FlowDiff

## Network Input Status

Table 49: Main Menu \ BMS Communications \ Network Input Status

Menu Display Name	Default	Range
Net OAT In	-	-50.0-200.0°F
Net SpaceT In	-	0.0-150.0°F
NetCurrState	-	Occ Unocc TntOvrd Standby NUL
NetNextState	-	Occ Unocc TntOvrd Standby NUL
NetTmToNxtSt	-	0-65534min
Net App Mode	-	Off HeatOnly CoolOnly FanOnly Auto NA
Net CI Ena S	-	-1.0-1.0
Net CI Ena V	-	0-255%
Net HT Ena S	-	-1.0-1.0
Net Ht Ena V	-	0-255%
Net Ec Ena S	-	-1.0-1.0
Net Ec Ena V	-	0-255%
Net SAF Cap	-	0-100%
Net EF Cap	-	0-100%
Net Space PPM	-	0-5000ppm
Net Rel Humid	-	0-100%
Net DATClg Spt	-	40.0-100.0°F
Net DATHtgSpt	-	40.0-140.0°F
Net DATHtgSpt	-	40.0-105.0°F
NetLCTSpt	-	45.0-65.0°F
NetDXBPLCTSpt	-	45.0-65.0°F
NetDemandShed	-	Inactive Auto Manual
nviSetpoint	-	0.0-100.0°F

Menu Display Name	Default	Range
NetOccManCmd	-	Occ Unocc TntOvrd Standby Auto
Net Min OA	-	0-100%
nvoEffSpt	-	0.0-100.0°F
nciOccClgSpt	-	0.0-100.0°F
nciOccHtgSpt	-	0.0-100.0°F
nciHVACType	-	Generic FanCoil VAV Hpump RTU UV ChilCeil Rad AHU SCU

## Power Monitor

The Power Monitor menu displays the relevant Inputs from the option Power Monitor Features. The Power Monitor is a reporting only feature.

**Table 50: Main Menu \ View Status \ Power Monitor**

Menu Display Name	Default	Range	Description
TotalUnitkWh	-	0.0-10000000.0	TotalUnit kWh - How much energy the unit has consumed – this is what a residential customer might get billed for on based on your power meter. This number is for reference only, the meter is not “revenue grade” and cannot be used for accurate billing.
UnitkW	-	0.0-1000000.0	UnitkW is how much energy is being consumed at an instantaneous moment in time. The kWhs is the integral of this value.
PeakUnitkW	-	0.0-1000000.0	PeakUnitkW is the highest instantaneous power that the meter has ever seen the unit draw. This can be used to track to see if starts are getting harder or if coils need to be cleaned.
AverageUnitkW	-	0.0-1000000.0	AverageUnitkW is the average power draw of the unit over a period. It is not the power consumption.
L1L2Voltage	-	0.0-700.0V	L1L2Voltage is the RMS voltage on a given phase.
L2L3Voltage	-	0.0-700.0V	L2L3Voltage is the RMS voltage on a given phase.
L1L3Voltage	-	0.0-700.0V	L1L3Voltage is the RMS voltage on a given phase.
L1kW	-	0.0-1000000.0	L1kW Power draw on each one of the three phases, which allows you to see if the power draw is equal across the phases.
L2kW	-	0.0-1000000.0	L2kW Power draw on each one of the three phases, which allows you to see if the power draw is equal across the phases.
L3kW	-	0.0-1000000.0	L3kW Power draw on each one of the three phases, which allows you to see if the power draw is equal across the phases.
L1Current	-	0.0-200.0A	L1Current is the current per phase. These should all be close together. If they are not they may indicate a loose connection or blown fuse.
L2Current	-	0.0-200.0A	L2Current is the current per phase. These should all be close together. If they are not they may indicate a loose connection or blown fuse.
L3Current	-	0.0-200.0A	L3Current is the current per phase. These should all be close together. If they are not they may indicate a loose connection or blown fuse.
NetSyskVAR	-	0.0-200.0	NetSyskVAR is the current reading of the System Total Reactive Power; which is the unsigned absolute value of kVAR L1 + kVAR L2 + kVAR L3. This is the imaginary portion of power (from a mathematical perspective) that we call VARs (Volt Ampere Reactive or Apparent Power). The ratio of real power to reactive power is the power factor. So this value in conjunction with real power can be used to determine power factor (Power Factor = True Power / Apparent Power).
kVAR L1	-	0.0-200.0	kVAR L1 is the current reading of the individual L1 phase reactive Energy LSW (kVARh) (Signed)
kVAR L2	-	0.0-200.0	kVAR L2 is the current reading of the individual L2 phase reactive Energy LSW (kVARh) (Signed)
kVAR L3	-	0.0-200.0	kVAR L3 is the current reading of the individual L3 phase reactive Energy LSW (kVARh) (Signed)
kVA L1		0.0-200.0	kVA L1 is the current Individual L1 Phase Apparent Powers (kVA) Signed
kVA L2		0.0-200.0	kVA L2 is the current Individual L2 Phase Apparent Powers (kVA) Signed

Menu Display Name	Default	Range	Description
kVA L3		0.0-200.0	kVA L3 is the current Individual L3 Phase Apparent Powers (kVA) Signed
Power Factor	-	0.0-200.0	Power Factor is the system Total Power Factor (PF) (Signed). The ratio of the real power to the reactive power. (Power Factor = True Power / Apparent Power)
Accm kVARh L1	-	0.0-1000000.0	Accm kVARh L1 is a running total of the reactive power hours that a given piece of equipment is consumed per phase.
Accm kVARh L2	-	0.0-1000000.0	Accm kVARh L2 is a running total of the reactive power hours that a given piece of equipment is consumed per phase.
Accm kVARh L3	-	0.0-1000000.0	Accm kVARh L3 is a running total of the reactive power hours that a given piece of equipment is consumed per phase.
Accum kVAh	-	0.0-1000000.0	Accum kVAh – How much energy the unit has consumed. This is what commercial customers likely will get billed for. This number is for reference only, the meter is not “revenue grade” and should not be used for accurate billing.

# Unit Maintenance and Service Menus

## Unit Maintenance

The **Unit Maintenance** section covers several menus that will be useful while maintaining the equipment.

## Operating Hours Menu

*Table 51: Main Menu \ Commission Unit \ Unit Maintenance \ Operating Hours*

Menu Display Name	Default	Range	Description
Supply Fan	-	0.0-999999.0h	Supply Fan is a status only item that displays the number run hours on the Supply Fan
Exh Fan	-	0.0-999999.0h	Exh Fan is a status only item that displays the number run hours on the Exhaust Fan
Cooling	-	0.0-999999.0h	Cooling is a status only item that displays the number run hours spent in Cooling
Heating	-	0.0-999999.0h	Heating is a status only item that displays the number run hours spent in Heating
2nd Heating	-	0.0-999999.0h	A status only item that displays the number of operating hours of the auxiliary heater
Economizer	-	0.0-999999.0h	Economizer is a status only item that displays the number run hours spent in Economizer
Tnt Override	-	0.0-999999.0h	Tnt Override is a status only item that displays the number run hours spent in Tnt Override
VCmp1	-	0.0-999999.0h	VCmp1 is a status only item that displays the number run hours for Variable Compressor 1
Dehumid	-	0.0-999999.0h	Dehumid is a status only item that displays the number run hours spent in Dehumidification
Reheat	-	0.0-999999.0h	Reheat is a status only item that displays the number run hours spent in Reheat
ER Wheel	-	0.0-999999.0h	ER Wheel is a status only item that displays the number run hours for the Energy Recovery Wheel
ER Preheat	-	0.0-999999.0h	ER Preheat is a status only item that displays the number run hours for the Energy Recovery Pre-heater
UV Lights	-	0.0-999999.0h	UV Lights is a status only item that displays the number of operating hours for the UV Lights

## Air Filters

**Table 52: Main Menu \ Commission Unit \ Unit Maintenance \ Air Filters**

Menu Display Name	Default	Range	Description
MainFltrSpt1=	0.5in	0.0-5.0in	An adjustable input to select the pressure at which a “dirty filter” flag becomes true for Filter bank 1
MainFltrPres1=	-	0.0-5.0in	A status only item which indicates the Pressure drop across Filter bank 1
MainFltrSpt2=	0.5in	0.0-5.0in	An adjustable input to select the pressure at which a “dirty filter” flag becomes true for Filter bank 2
MainFltrPres2=	-	0.0-5.0in	A status only item which indicates the Pressure drop across Filter bank 2
MainFltrSw=	-	Open Closed	A status only item which indicates the state of the Main Filter Switch

## Timer Settings

The Timer Settings menu contains adjustable timers for various unit functions. This menu is also available in the Commission Unit menu (Main Menu \ Commission Unit \ Timer Settings).

**Table 53: Main Menu \ Service Menus \ Timer Settings**

Menu Display Name	Default	Range	Description
Start Up	180s	30-1800s	Startup is an adjustable item that sets the time in seconds that the unit will perform its startup operation.
Recirculate	180s	60-3600s	Recirculate is an adjustable item that sets the time in seconds that the unit operates with only the fan, recirculating the building air upon unit start up.
Clg Stg Time	5min	5-60min	Clg Stg Time is an adjustable item used to set a minimum time period between compressor stage changes.
Htg Stg Time	5min	2-60min	Htg Stg Time is an adjustable item used to set a minimum time period between heating stage changes.
Zero OA Time	0min	0-240min	Zero OA Time is an adjustable item that sets the time in minutes that the outdoor air damper stays at a zero position upon unit start up.
Tnt Ovr Incr	120min	0-300min	Tnt Ovr Incr is an adjustable item that sets the amount of time that the unit will go into operation when the tenant override function is activated. Tenant override can be activated by the space sensor button, the network occupancy mode parameter or the keypad Occ Mode= parameter.
Post Heat	0s	0-180s	Post Heat is an adjustable item that sets the duration of the post heat function available on VAV units.
Low DAT	6min	0-60min	Low DAT is an adjustable item that sets the duration of a time period upon unit start up during which the Low Discharge Temperature fault is ignored. This may be particularly important in colder climates when a unit has been off for a significant time period during which the unit, including the discharge air temperature sensor, has become very cold. This time period allows the unit to run long enough to turn the unit heat on and warm the discharge sensor above the alarm limit, preventing nuisance unit alarm shutdown. This time period begins when the supply fan starts.
Service Time	0min	0-60min	Service Time is an adjustable item that sets the amount of time the internal control timers can be temporarily sped up.



## Operating Hours

The Operating Hours menu contains status items that display the number run hours for various components and operating states. This menu is also available in the Commission unit menu (Main Menu \ Commission Unit \ Unit Maintenance \ Operating Hours).

**Table 54: Main Menu \ Service Menus \ Operating Hours**

Menu Display Name	Default	Range	Description
Supply Fan	-	0.0-999999.0h	Supply Fan is a status only item that displays the number run hours on the Supply Fan
Exh Fan	-	0.0-999999.0h	Exh Fan is a status only item that displays the number run hours on the Exhaust Fan
Cooling	-	0.0-999999.0h	Cooling is a status only item that displays the number run hours spent in Cooling
Heating	-	0.0-999999.0h	Heating is a status only item that displays the number run hours spent in Heating
2nd Heating	-	0.0-999999.0h	A status only item that displays the number of operating hours of the auxiliary heater
Economizer	-	0.0-999999.0h	Economizer is a status only item that displays the number run hours spent in Economizer
Tnt Override	-	0.0-999999.0h	Tnt Override is a status only item that displays the number run hours spent in Tnt Override
VCmp1	-	0.0-999999.0h	VCmp1 is a status only item that displays the number run hours for Variable Compressor 1
Dehumid	-	0.0-999999.0h	Dehumid is a status only item that displays the number run hours spent in Dehumidification
Reheat	-	0.0-999999.0h	Reheat is a status only item that displays the number run hours spent in Reheat
ER Wheel	-	0.0-999999.0h	ER Wheel is a status only item that displays the number run hours for the Energy Recovery Wheel
UV Lights	-	0.0-999999.0h	A status only item that displays the number of operating hours of the UV Lights

## Temperatures

The Temperatures menu displays the current reading of many of the key temperature sensors throughout the unit.

**Table 55: Main Menu \ View Status \ Temperatures**

Menu Display Name	Default	Range	Description
Control Temp	-	-50.0-200.0°F	Control Temp is a status only item which indicates the current Control Temperature value.
Disch Air	Auto/Net	-50.0-250.0°F	Disch Air is a status only item which displays the current temperature reading from the unit's discharge air temperature sensor (DAT). This sensor is standard on all units.
Return Air	-	-50.0-200.0°F	Return Air is a status only item which displays the current temperature reading from the unit's return air temperature sensor (RAT).
Eff Space T	-	0.0-150.0°F	Eff Space T is a status only
Space Temp 1		0.0-150.0°F	Space Temp 1 is a status only item which displays the current temperature reading from a space temperature sensor. Up to 3 sensors can be attached to the unit.
Space Temp 2		0.0-150.0°F	Space Temp 2 is a status only item which displays the current temperature reading from a space temperature sensor. Up to 3 sensors can be attached to the unit.
Space Temp 3		0.0-150.0°F	Space Temp 3 is a status only item which displays the current temperature reading from a space temperature sensor. Up to 3 sensors can be attached to the unit.
OA Temp		-50.0-200.0°F	OA Temp is a status only item which displays the current temperature reading from the unit mounted outdoor air temperature sensor.
EF/LC Temp		-50.0-250.0°F	EF/LC Temp is a status only item which displays the current entering fan/leaving coil temperature reading from the unit mounted temperature sensor. This sensor is available on RTU units with dehumidification capability. This sensor is also installed on RTU units equipped with either gas or electric heat and is used by the controller to calculate the heat rise across the heat exchanger by comparing it to the discharge air temperature input. The controller uses this information to protect the heat exchanger against overheating.
ER LWT		-50.0-200.0°F	ER LWT is status only item which displays the current discharge air temperature leaving the optional energy recovery wheel.
ER EWT		-50.0-200.0°F	ER EWT is status only item which displays the current exhaust air temperature leaving the optional energy recovery wheel.
C1DRT1	-	-83.2-392.0°F	A status only item which indicates the Discharge Refrig. Temperature of Circ 1/ Comp 1
C1DRT3	-	-83.2-392.0°F	A status only item which indicates the Discharge Refrig. Temperature of Circuit 1/ Comp 3
SRT1		-50.0-200.0°F	SRT1 is a status only item which displays the current suction refrigerant line temperature sensor reading on Circuit #1
DFT1	-	-83.2-212.0°F	A status only item which indicates the Defrost Refrig. Temperature of Circuit 1
VCmp1 Temp		-50.0-392.0°F	VCmp1Temp is a status only item which displays the current temperature of variable Compressor 1
LRT1	-	-83.2-212.0°F	LRT1 is a status only item which displays the current liquid refrigerant line temperature sensor reading on Circuit #1

## Alarms and Events

**Alarms** provide the user with information about abnormal conditions that affect unit operation. The cause of the alarm should be investigated and eliminated before the unit or any disabled equipment in it is placed back into service.

### Viewing Alarms

The **Active Alarms** menu displays up to 10 active alarms. Pushing the scroll wheel in, will show details about the alarm, as well as when it occurred. The Alarm Log, shows the same information, but up to 50 of the latest alarms - both active and previous alarms.

Alarms are categorized as **Warnings, Problems or Faults**.

**Faults** are conditions that are serious enough to shut down the unit. The alarm must be manually cleared to allow unit operation.

**Problems** are conditions that result in some limitation of unit

operation, but the unit is allowed to continue to operate. Some of these alarms must be cleared manually, but others clear automatically.

**Warnings** inform the user of conditions that should be addressed, but do not limit operation in any way. The alarm condition needs to be fixed and the alarm must be manually cleared to cause this alarm to no longer be active.

All active alarms as well as the date and time that they were detected are displayed on the Active Alarm menu. These alarms are displayed in order of priority. Higher priority alarms are displayed first. The last 50 alarm "events" detected, as well as the date and times that they were detected, are displayed on the Alarm Log menu. An alarm "event" is either an alarm becoming active, or being cleared. A "+" symbol precedes the active alarm event and a "-" symbol precedes the cleared alarm event. These alarms are displayed in the order that they were detected. The alarm that was detected most recently is displayed first. Multiple occurrences of the same alarm may appear.

**Table 56: Main Menu \ Service Menus \ Active Alarms**

Menu Display Name	Default	Range	Description
Alarm Ct: ** Clr Alms	- : No	0-78: No Flts Prbs Wrns All	The top of the alarm menu will show the current count of alarms and their types.
Alarm1: Alarm Type	-	Dirty Filter: Warning – Freeze: Fault	The Alarm will display the alarm name : Alarm Type
Alarm Date Alarm Time	-	01/01/1970-01/01/9999 00:00:00-23:59:59	Each alarm will display the date and time the alarm occurred.

**Table 57: Main Menu \ Service Menus \ Alarm Log**

Menu Display Name	Default	Range	Description
LogCt:** Clr Log:	- : No	0-78: No Yes	The top of the alarm menu will show the current count of alarms and their types.
+Alarm:Alarm Type	-	Dirty Filter: Warning – Freeze: Fault	The Alarm will display the alarm name : Alarm Type
Alarm Date Alarm Time	-	01/01/1970-01/01/9999 00:00:00-23:59:59	Each alarm will display the date and time the alarm occurred.

## Alarm and Event Descriptions

### Warnings

Warnings are notifications only. No action is taken by the controller in response to a Warning.

**Table 58: Main Menu \ Service Menus \ Active Alarms**

Alarm Number	Alarm Display Name	Description
0	No Active Warnings	No Active Warnings are indicated.
24	Main Filter: Warning	A warning alarm indicating the unit Main filter bank is dirty. The filter is considered dirty when the FilterSw1 across the Main filter bank is in alarm continuously for 60 seconds or Filter press 1 or 2 analog inputs is above the HiFltPress1Spt continuously for 60 seconds. This alarm requires a manual clear.
34	Exh Fan: Warning	A warning alarm indicating the unit Exh Fan status is not as expected. This warning occurs only on units equipped with exhaust fans when the EF Status is expected to be true and it is false for at least 30 seconds. This alarm will automatically clear if status changes to the expected vale.
50	Over Econo: Warning	<p>A warning alarm indicating the unit is economizing when it should not be will be generated whenever the outdoor air dampers are stuck open while operating in the Econo or Cooling operating state. The dampers are considered stuck open when either of the following abnormal situations occurs:</p> <ul style="list-style-type: none"> <li>• The damper command value is less than the calibrated damper end switch closed value continuously for 180 seconds yet the outside air damper end switch input remains open.</li> <li>• The damper end switch input does not change from closed to open with 30 seconds of the damper command value dropping (and remaining) below the calibrated damper end switch open value (less the calibrated maximum switch differential).</li> </ul> <p>The over economizing warning will also be generated if the Econo Status is Enabled when the OAT is greater than the Max OAT Limit setting (default 75F). Exception: This case is ignored when the economizer enable decision is being controlled by a network input or when the economizer changeover method (EconChgovr) is set for OAT/RAT dry bulb comparison (OAT/RAT).</p> <p>The alarm will automatically clear when the conditions causing the alarm are no longer present.</p> <p>NOTE: The damper end switch open (PosSwOpen%), Minimum switch differential (MinSwDiff), damper end switch closed (PosSwClose%) and maximum switch differential (MaxSwDiff) values are determined during the OAD damper end switch calibration process.</p>

Alarm Number	Alarm Display Name	Description
52	Under Econo: Warning	<p>A warning alarm indicating the unit is not economizing when it should be will be generated whenever the outdoor air dampers are stuck closed while operating in the Econo or Cooling state. The dampers are considered stuck closed when either of the following abnormal situations occurs:</p> <ul style="list-style-type: none"> <li>• The damper command value is greater than the calibrated damper end switch open value continuously for 180 seconds yet the outside air damper end switch input remains open.</li> <li>• The damper end switch input does not change from closed to open with 30 seconds of the damper command value rising above the calibrated damper end switch closed value (plus the calibrated minimum switch differential).</li> </ul> <p>The under economizing alarm will also be generated if the Econo Status is not Enabled when the OAT is less than the Min OAT Limit setting (default 70F). Exception: This case is ignored when the economizer enable decision is being controlled by a network input or when the economizer changeover method (EconChgovr) is set for OAT/RAT dry bulb comparison (OAT/RAT).</p> <p>The under economizing alarm will also be generated when the OAT sensor is unreliable or the RAT sensor is unreliable while the OAT is below the Min OAT Limit setting (default 70F) and the economizer changeover method (EconChgovr) is set for OAT/RAT dry bulb comparison (OAT/RAT).</p> <p>The alarm will automatically clear when the conditions causing the alarm are no longer present.</p> <p>NOTE: The damper end switch open (PosSwOpen%), Minimum switch differential (MinSwDiff), damper end switch closed (PosSwClose%) and maximum switch differential (MaxSwDiff) values are determined during the OAD damper end switch calibration process.</p>
54	Excess OA: Warning	<p>A warning alarm indicating the unit is delivering excessive outdoor air will be generated whenever the outdoor air dampers are stuck open. The outdoor dampers are considered stuck open when either of the following abnormal situations occurs:</p> <ul style="list-style-type: none"> <li>• The damper command value is less than the calibrated damper end switch closed value continuously for 180 seconds yet the outside air damper end switch input remains open.</li> <li>• The damper end switch input does not change from closed to open with 30 seconds of the damper command value dropping (and remaining) below the calibrated damper end switch open value (less the calibrated maximum switch differential).</li> </ul> <p>The excess outdoor air warning will also be generated while operating in the Econo or Cooling state when the Econo Status is Enabled and the OAT is greater than the Max OAT Limit setting (default 75F). Exception: This case is ignored when the economizer enable decision is being controlled by a network input or when the economizer changeover method (EconChgovr) is set for OAT/RAT dry bulb comparison (OAT/RAT).</p> <p>The alarm will automatically clear when the conditions causing the alarm are no longer present.</p> <p>NOTE: The damper end switch open (PosSwOpen%), Minimum switch differential (MinSwDiff), damper end switch closed (PosSwClose%) and maximum switch differential (MaxSwDiff) values are determined during the OAD damper end switch calibration process.</p> <p>The alarm will automatically clear when the conditions causing the alarm are no longer valid.</p>

Alarm Number	Alarm Display Name	Description
56	OADStuck: Warning	<p>A warning alarm indicating the outdoor air dampers are stuck and not modulating will be generated whenever the damper are stuck open or stuck closed.</p> <p>The dampers are considered stuck open when either of the following abnormal situations occurs:</p> <ul style="list-style-type: none"> <li>• The damper command value is less than the calibrated damper end switch closed value continuously for 180 seconds yet the outside air damper end switch input remains open.</li> <li>• The damper end switch input does not change from closed to open with 30 seconds of the damper command value dropping (and remaining) below the calibrated damper end switch open value (less the calibrated maximum switch differential).</li> </ul> <p>The dampers are considered stuck closed when either of the following abnormal situations occurs:</p> <ul style="list-style-type: none"> <li>• The damper command value is greater than the calibrated damper end switch open value continuously for 180 seconds yet the outside air damper end switch input remains open.</li> <li>• The damper end switch input does not change from closed to open with 30 seconds of the damper command value rising above the calibrated damper end switch closed value (plus the calibrated minimum switch differential).</li> </ul> <p>The damper stuck warning will also be generated when the damper end switch operation is unreliable. The ends switches are considered unreliable when the end switch input remains closed when the damper command value is between the calibrated end switch closed and open values (plus and minus the calibrated minimum and maximum switch differentials).</p> <p>The alarm will automatically clear when the conditions causing the alarm are no longer present.</p>
58	ERWheel: Warning	<p>Some units are equipped with a wheel rotation detection capability. This is present if the wheel is using an ECM motor. The ERWheel Warning flag is present if the wheel rotation is not detected. The alarm will automatically clear when the conditions causing the alarm are no longer present.</p>

## Problems

Problems class alarms will not cause the unit to shut down completely but generally mean unit operation is altered in some way.

**Table 59: Main Menu \ Service Menus \ Problem Alarms**

Alarm Number	Alarm Display Name	Description
0	No Active Problems	No Active Problems
101	MHGRhtVlv1: Problem	The MHGRhtVlv1 Problem occurs when MHGRht valve synchronization sequence has started and is not completed successfully. As a result, the Dehumidification operation will be disabled unless primary heat back up reheat is available. This problem requires a Manual clear of the alarm.
105	DRT1 Sensor: Problem	This alarm occurs when the DRT1 (Discharge Refrigerant Temperature) sensor input is shorted or open circuited for the Sensor Alarm Delay (default 30 seconds). It can also occur when the variable speed compressor is off and the input is above 329°F or the compressor has been off for 20 minutes and the input is below -4°F. When this alarm is active compressor cooling operation is disabled. The alarm must be manually cleared once corrective action is taken.
109	ProtIntrck: Problem	When configured for refrigeration only control there is generic interlock digital input defined that must be made to allow cooling operation (for an airflow switch for example). If the field calls for cooling but this input is not made you end up with the ProtIntrck: Problem alarm.
110	VCmp1: Problem	If the Variable Speed Compressor on Circuit 1 or Circuit 2 is enabled and commanded to run for 30 seconds but the controller fails to receive the variable speed run verification input the variable speed compressor is cycled OFF (a variable speed Compressor Emergency Stop Control Event is logged) for 5 seconds and then back on. The variable speed compressor is then ramped to 45%. If this occurs 5 times in a 100 min period the variable speed compressor is shut off and the VCmp1 Problem alarm is generated. This alarm must be manually cleared once corrective action is taken.
115	SRT Sensor 1: Problem	This alarm occurs when the SRT1 Sensor (Suction Refrigerant Temperature) sensor input is shorted or open for the Sensor Alarm Delay (default 30s) It can also occur when the variable speed compressor is off and the input is above 329°F.
120	Hi DL Temp_1: Problem	Normal compressor control is limited when a high discharge line temperature conditions occur. If the variable speed compressor is operating and the discharge line temperature is greater than 250F for 15 seconds a High Discharge Line Temperature Event is generated and the variable speed compressor capacity is reduced every 15 seconds until the discharge line temperature falls below 220F. If the discharge line temperature is above 250F continuously for 3 minutes the variable speed compressor is stopped and a High Discharge Line Temperature problem alarm is generated. The alarm must be manually cleared.
125	Exp Valve 1: Problem	Exp Valve 1 or 2 Problem indicates the EVI valve resync Counter is greater than or equal to 4 or that EVI synchronization sequence is not completed within 60 seconds. This alarm must be manually cleared once corrective action is taken.
130	OA Fan 1: Problem	Outdoor Fan 1 or 2 Problem indicates
135	PTS1 Sensor: Problem	PTS1 or 2 Sensor Problem indicates the a sensor malfunction. This alarm is present when the following is true for 30 seconds where PTS<96kPa and the CircState is not in pumpdown or where the following is true for 30 minutes; the SSH1-SSHSpt >20.0F, DSH1<5.0F, and EVI Pos >95%. This alarm must be manually cleared once corrective action has been taken.
140	PTD1 Sensor: Problem	This alarm occurs when either the circuit 1 discharge line pressure inputs (PTD1) remains above 705 psi for 10 seconds or a compressor on circuit 2 has been operating for 60 seconds and the PTD1 value remains less than 155 psi. When this alarm is active compressor cooling operation is disabled. The alarm must be manually cleared once corrective action is taken.
145	Lo Charge 1: Problem	The Lo Charge 1 Problem alarm indicates a condition that is consistent with a low refrigerant charge on circuit 1. This alarm occurs when the suction super heat is more than 20F greater than the set point, the expansion valve is >95% open for more than 30 min. This alarm must be manually cleared once corrective action has been taken.

Alarm Number	Alarm Display Name	Description
150	ChargeLoss 1: Problem	The ChargeLoss 1 or 2 Problem alarm indicates a condition where the charge is not present. This alarm occurs when the suction superheat is more than 20F greater than the set point, the expansion valve is >95% open and the HDRT is > 150.0F for 30 minutes. This alarm must be manually cleared once corrective action has been taken.
155	VCmp1LoDSH: Problem	The VCmp1LoDSH Problem alarm indicates a condition where the variable compressor has been disabled due to 3 lo discharge super heat events. This alarm must be manually cleared once corrective action has been taken.
160	Lo Press 1: Problem	The Lo Press 1 Problem alarm indicates a condition a low pressure condition on a circuit. This condition occurs when the low pressure switch input has been in alarm (open) position for longer than the LP Pressure Switch Delay (Default = 2 Seconds). This alarm will automatically reset if the Lo Pressure Event has not occurred more than 4 times in 24 hours. Otherwise a manual clear is required once action has been taken.
165	Hi Press 1: Problem	Normal variable speed compressor control is limited when a high discharge pressure conditions occur on the variable speed compressor circuit. If the variable speed compressor is operating and the discharge pressure (PTD) is greater than 525 PSI, a High Pressure Unloading Control Event is generated and the variable speed compressor is slowed every 10 seconds until either the discharge pressure falls to less than 525 PSI or remains higher than 575 PSI for 10 minutes. If the discharge pressure is above 575 PSI for 10 minutes the variable speed compressor is shut off and a High Pressure Problem alarm is generated. If the OAT is below 45F at the time the variable speed compressor is shut off immediately and a High Pressure Problem alarm is generated anytime the discharge pressure rises above 575 PSI. The alarm must be manually cleared.
170	Lo Press Diff 1: Problem	The Lo Pressure Diff Problem alarm indicates a condition where the differential pressure between the high and low side of the refrigeration circuit becomes too low for proper oil lubrication in the inverter compressor. This alarm occurs when the counter exceeds 3 events in a 45 min period. Alarm requires manual reset once corrective action is taken.
175	HiVCmpTmp 1: Problem	The HiVCmpTmp Problem alarm indicates a condition where the variable speed compressor exceeds its maximum temperature of 248F for 5 seconds. The alarm automatically resets after 100 min if the condition does not occur again.
180	VCmpTSnsr 1: Problem	The VCmpTSnsr Problem alarm indicates a condition where the compressor temp sensor is present and shorted. The alarm requires manual clearing after manually cleared.
185	VCmp1HiDSH: Problem	The VCmp1HiDSH Problem alarm indicates a condition where the discharge super heat is detected and the compressor is forced to standby to prevent the variable speed compressor from operating under high motor, discharge port or oil temperature conditions. The alarm requires manual clearing.
190	IFB1 Comm: Problem (VCmp1 & 2)	The IFB1 Comm Problem alarm indicates a condition where the HP switches are normal and the IFB comm module has a loss of communication. This alarm automatically clears when comms are re-established unless there are 5 occurrences in a 100 minute period.
192	EFT/LCT Snsr: Problem (Control Type: ZTC, DTC or 1ZnVAV)	This alarm occurs when the Entering Fan Temperature/Leaving Coil Temperature sensor is present and either shorted or open circuited for longer than the Sensor Alarm Delay (Default = 30 seconds). When this alarm occurs the unit continues to operate however dehumidification operation is disabled until the sensor becomes reliable. The maximum DAT limit function associated with gas or electric heat is also disabled until the sensor becomes reliable.
193	RAT Sensor: Problem (Control Type: ZTC, DTC or 1ZnVAV)	If the return air temperature sensor (RAT) is present and either shorted or open circuited for longer than the Sensor Alarm Delay (default is 30 seconds), the Return Air Sensor problem occurs. When the RAT Sensor problem occurs, the unit continues to operate with the following modifications: Cooling Reset and Heating Resets revert to None if they are set to Return and Control temperature Source reverts from return to space temperature if a space temperature is present and reliable. When the alarm condition is no longer present, the RAT sensor problem automatically clears.



Alarm Number	Alarm Display Name	Description
194	Space Sensor 1: Problem (Control Type: ZTC, DTC or 1ZnVAV)	If the space air temperature sensor (SAT) is present and either shorted or open circuited for longer than the Sensor Alarm Delay (default is 30 seconds), the Space Sensor problem occurs. When the SAT Sensor problem occurs, the unit continues to operate with the following modifications: Cooling Reset and Heating Resets revert to None if they are set to Space and Control temperature Source reverts from Space to return temperature if a return temperature is present and reliable. When the alarm condition is no longer present, the Space sensor problem automatically clears.
195	Space Sensor 2: Problem (Control Type: ZTC, DTC or 1ZnVAV)	
196	Space Sensor 3: Problem (Control Type: ZTC, DTC or 1ZnVAV)	
197	OAT Sensor: Problem	If the outside air temperature sensor (OAT) is present, a valid OAT value is not provided via the network and the local OAT sensor is either shorted or open circuited for longer than the Sensor Alarm Delay (default is 30 seconds), the Outside Air Sensor problem occurs. When the OAT Sensor problem occurs, the unit continues to operate with the following modifications: Heating is not locked out due to high OAT, Cooling is not locked out due to low OAT, Cooling Reset and Heating Reset revert to none if they are set to OAT and Economizer is locked out due to high OAT. When the alarm condition is no longer present, the OAT Sensor problem automatically clears.
198	Freeze: Problem (Control Type: ZTC, DTC or 1ZnVAV)	<p>When a unit is equipped with chilled water, hot water, or steam coil, the Freeze problem occurs when the optional freezestat contacts open as a result of detecting an abnormally low water or steam coil temperature while the fans are off.</p> <p>When the Freeze problem occurs, the controller opens the chilled water and heating valves, and sets a 10-minute timer. When the 10-minute timer expires, the controller checks the freezestat input again. If the freezestat contacts are closed the valves close. If the freezestat contacts are still open, the valves remain open, and the 10-minute timer resets. This continues while the unit remains off. Whenever the freezestat closes the Freeze problem automatically clears. This feature protects the coil(s) and allows the system to start normally when an occupied command is received.</p>
199	Heat Fail: Problem (Control Type: ZTC, DTC or 1ZnVAV)	When a unit is equipped with a Natural Gas or Propane Burner and the modulating burner Modbus status is Fault for 20 seconds. This automatically clears once communications are reestablished.

## Faults

Faults class alarms will cause the unit to shut down completely.

**Table 60: Main Menu \ Service Menus \ Fault Alarms**

Alarm Number	Alarm Display Name	Description
0	No Active Faults	No Active Faults is displayed when there are no active faults.
208	Airflow: Fault	The Airflow Fault occurs when the fan does not provide flow feedback after 5 start tries. This requires a manual clear once corrective action has been taken.
212	Lo Disch Temp: Fault	The Lo Disch Occurs If the unit is not in the operating state and the discharge air temperature is less than the Low Discharge Temperature Limit (Default = 40°F) for longer than 35 seconds and the supply fan has been on for longer than the LowDAT temperature alarm delay (Default = 6 minutes), the Low Discharge Air Temperature fault occurs. When the Low Discharge Air Temperature fault occurs, the unit is shut down. It remains shut down until the Low Discharge Air Temperature fault is manually cleared through the unit keypad or via a network signal.
216	Hi Disch Temp: Fault	If the discharge air temperature is greater than the High Discharge Temperature Limit (Default = 170°F) and the supply fan has been on for longer than the Temperature Alarm Delay (Default = 35 seconds), the High Discharge Air Temperature fault occurs. When the High Discharge Air Temperature fault occurs, the unit is shut down. It remains shut down until the High Discharge Air Temperature fault is manually cleared through the unit keypad or via a network signal.
220	Hi Return Tmp: Fault	If the return air temperature is greater than the Return Air Temperature Limit (Default = 120°F) and the supply fan has been on for longer than the temperature alarm delay (Default= 35 seconds), the High Return Air Temperature fault occurs. When the High Return Air Temperature fault occurs, the unit is shut down. It remains shut down until the High Return Air Temperature fault is manually cleared through the unit keypad or via a network signal.
224	Duct Hi Limit: Fault	If the unit is variable air volume, the contacts of the duct high pressure limit control (DHL) open, and the unit state is not Off or Startup, the Duct High Limit fault occurs. When the Duct High Limit fault occurs, the unit is shut down. The unit remains shut down until the Duct High Limit fault is manually cleared through the unit keypad or via a network signal.
228	Disch Tmp: Fault	If the discharge air temperature sensor (DAT) is open or short circuited for longer than the Sensor Alarm Delay (Default= 30 seconds), the Discharge Air Sensor fault occurs. When the Discharge Air Sensor fault occurs, the unit is shut down. It remains shut down until the Discharge Air Sensor fault is manually cleared through the unit keypad or via a network signal.
244	Control Temp: Fault	If the temperature sensor (ZNT1, RAT, OAT, MAT) selected as the control temperature source is not reliable for longer than the Sensor Alarm Delay (Default= 30 seconds), a Control Temperature Fault occurs. When the Control Temperature Fault occurs, the unit is shut down. It remains shut down until the Control Temperature Fault is manually cleared through the unit keypad or via a network signal.
250	Emerg Stop: Fault	An Emergency Stop Fault will occur if either of the following conditions is true: Emergency Stop Input in the Alarm (Open) condition Or The Net Emrg OvrD input is set to Off via a network signal or the keypad/display.
252	Freeze: Fault	When a unit is equipped with chilled water, hot water, or steam coil, the Freeze Fault occurs when the optional freezestat contacts open as a result of detecting an abnormally low water or steam coil temperature while the fans are running.  When the Freeze fault occurs, the controller shuts down the fans, opens the chilled water, economizer, and heating valves and set a 10-minute timer. When the 10-minute timer expires, the controller checks the freezestat input again. If the freezestat contacts are closed the pump output is de-energized and the valves close. If the freezestat contacts are still open the pump output remains energized, the valves remain open, and the 10-minute timer resets. This continues until the fault is manually cleared through the keypad or via a network signal.

# Viewing Events

## Event Log

**Table 61: Main Menu \ Service Menus \ Events**

Event Name	Description
FanRetry_Event (Control Type: ZTC, DTC or 1ZnVAV)	Supply Fan Retry Active
TenantOR_Event (Control Type: ZTC, DTC or 1ZnVAV)	Tenant Overridden Operation Active
Passive Vent_Event	Passive Ventilation Sequence Active
Passive Ventilation Sequence Active	Circuit 1 High Pressure Unloading Control Active
HPUL1_Event	Circuit 1 VCmp High Pressure Unloading Control Active
LPUL1_Event	Circuit 1 VCmp or FCmp Low Pressure Unloading Control Active
HDLTUL1_Event	Circuit 1 VCmp or FCmp High Discharge Line Temperature Unloading Control Active
HiAmpUL1_Event	Circuit 1 High Current Unloading Control Active
ReqUL1_Event	Circuit 1 Unload Request Control Active
HCRUL1_Event	Circuit 1 High Compression Ratio Unloading Control Active
FinTUL1_Event	Circuit 1 High Fin Temperature Unloading Control Active
LDPUL1_Event	Circuit 1 Low Differential Pressure Unloading Control Active
Reheat Lmtg_Event	Reheat Compressor Limiting Control Active
HiAmb1Lmtg_Event	Fixed Compressor Circuit 1 High Ambient Limiting Control Active
LoSSH1_Event	Circuit 1 Low Suction Superheat Conditions Present
HiSSH1_Event	Circuit 1 High Suction Superheat Conditions Present
LoSubClg1_Event	Circuit 1 Low Subcooling Conditions Present
LoDSH1_Event	Circuit 1 Low Discharge Superheat Conditions Present
HiDSH1_Event	Circuit 1 High Discharge Superheat Conditions Present
LoTc1_Event	Circuit 1 Low Tc Conditions Present
HiTc1_Event	Circuit 1 High Tc Conditions Present
LoTe1_Event	Circuit 1 Low Te Conditions Present
HiTe1_Event	Circuit 1 High Te Conditions Present
HiDRT1_Event	Circuit 1 High Discharge Refrigerant Temperature Conditions Present
HiSRT1_Event	Circuit 1 High Suction Refrigerant Temperature Conditions Present
LowOilPrevent1_Event	Circuit 1 Low Oil Prevent Conditions Present
HeatRiseLmiting_Event	DAT – EF/LC Temp Exceeding Max Heat Rise

## Standby Events

**Table 62: Main Menu \ Service Menus \ Standby Events**

Event Name	Description
HPSB_Event	CircState forced to standby by the High Pressure Unloading Control function
LPSB_Event	CircState forced to standby by the Low Pressure Unloading Control function
HDLTSB_Event	CircState forced to standby by the High Discharge Line Temperature Unloading Control function
LDPSB_Event	CircState forced to standby by the Low Differential Pressure Protection Unloading Control function
HiTSB_Event	CircState forced to standby by the Compressor Body High Temperature Protection function
OAFSB_Event	CircState forced to standby due to a fault detected by the outdoor fan control board
VCmpReqSB_Event	CircState forced to standby due to a request from the variable compressor control board
VCmpPrbSB_Event	CircState forced to standby by the due to a fault detected by the variable compressor control
EVSynSB_Event	CircState forced to standby by the expansion valve resynchronization function
LoDSHdsbl_Event	CircState forced to standby by the Low Discharge Superheat Protection function
HiDSHSB_Event	CircState forced to standby by the high discharge superheat protection function
OAFReqSB_Event	CircState forced to standby due to a fan control board request

## Event Troubleshooting

**Table 63: Main Menu \ Service Menus \ Event Troubleshooting**

MicroTech Event Name	Event Description	Possible Field Actions			
LoSSH1_Event	Low Suction Superheat	TXV adjustment	Low evap airflow	TXV Malfunction	
HiSubClg1_Event	High Suction Superheat	TXV adjustment	TXV Malfunction	Low charge	
LoDSH1_Event	Low Subcooling	Low charge	Dirty/fouled condenser coil	Condenser Fan motor issue	
HiDSH1_Event	High Subcooling	Overcharge			
LoDSH1_Event	Low Discharge superheat	TXV adjustment	TXV Malfunction		
HiDSH1_Event	High Discharge superheat	TXV adjustment	TXV Malfunction	Low charge	
LoTc1_Event	Low Condensing Temp	Condenser Fan Staging/Modulation	Cond Splitter Solenoid Malfunction		
HiTc1_Event	High Condensing TempD	Dirty/fouled condenser coil	Cond Splitter Solenoid Malfunction	Condenser Fan motor issue	Overcharge
LoTe1_Event	Low Evaporator Temp	Dirty filter	Low load/Low RA Temp		
HiTe1_Event	High Evaporator Temp	High load/High RA Temp			
HiDRT1_Event	High Discharge Temp	Low charge	TXV Malfunction		
HiSRT1_Event	High Suction Temp	TXV adjustment	TXV Malfunction	Low charge	

## Alarm/Event Configurations

Some Alarm/Event Configurations can be customized based on application. Several temperature limits can be adjusted and logging of alarms can be customized and captured to SD cards based on the configurations set in the Alarm Config Menu.

**Table 64: Main Menu \ Service Menus \ Alarm/Event Config Menu**

Menu Display Name	Default	Range	Description
<b>ALARM LIMITS</b>			
Hi DAT Limit	170°F	90.0-250.0°F	Hi DAT Limit is a adjustable set point for the Hi Discharge air temperature limit alarm.
Lo DAT Limit	40°F	-50.0-50.0°F	Lo DAT Limit is an adjustable set point for the Lo Discharge Air Temperature Limit alarm.
Hi RAT Limit	170°F 120°F	90-175°F	Hi RAT Limit is an adjustable set point for the Hi Return Air Temperature Limit.
<b>ALARM OUT CONFIG</b>			
Faults	Fast	On Off Fast Slow	Faults are conditions serious enough to shut down the unit operation. The alarm must be manually cleared to allow unit operation.
Problems	Slow	On Off Fast Slow	Problems are conditions that result in some limitation of unit operation, but the unit is allowed to continue to operate. Some of these alarms must be cleared manually, but others clear automatically.
Warnings	Off	On Off Fast Slow	Warnings Inform the user of conditions that should be addressed, but do not limit the operation in any way.. The alarm condition needs to fixed and the alarm must be manually cleared to cause this alarm to no longer be active.
AlmLogToSD	No	No SI English	AlmLogToSD sets if the alarms are logged on the SD card.
<b>EVENT CONFIG</b>			
Show Events	Yes	No Yes	Show Events is a flag that sets that we are seeing the events log.
EventLogToSD	No	No SI English	EventLogToSD is the Flag that sets if the event log is saved to the SD Card.
<b>SNAPSHOT CONFIG</b>			
SnaptshotsToSD	No	No SI English	SnaptshotsToSD is the Flag that sets if the snapshot log is saved to the SD Card.

## Data Snapshots

Data Snapshots will provide a means of recording certain unit operating conditions at the moment of an alarm or event occurrence. The MicroTech controller is capable of capturing up to 10 snapshots (sets of data) each containing up to 25 data points for each alarm or event. "Data Set 1-5" on page 177 and "Data Set 6-10" on page 178 for data snapshots that are captured whenever any alarm or event becomes active.

# MicroTech Inputs/Outputs

The complete set of Inputs and Outputs that are possible on a MicroTech are listed below. These vary by configuration and may or not be included on any given unit based on the features selected and shipped from the factory.

## Main Control Board

Table 65: Main Control Board

Universal Inputs/Outputs						
#	DI	AI	DO	AO	Point	Comments
X1		X			Space Temperature Sensor 1	10K Thermistor Coefs/InputType = 7
		X			Compressor Capacity Command Input	0-10VDC
X2		X			CO2/ExtOAReset	0-10VDC or 4-20 mA
				X	Actual Compressor Capacity Output	0-10VDC
X3		X			Reheat Capacity Input	0-10VDC
				X	Heating Valve	2-10 VDC
				X	SCR	1-10 VDC
X4				X	OA Damper	0-10 VDC
X4		X			Heating Capacity Input	0-10 VDC
X5		X			Zone Setpoint	5 – 15 kOhm
		X			DAT Reset	0-10VDC/4-20mA
		X			Supply Fan Cap Command	0-10 VDC
X6		X			SAF Duct Static Pressure	4-20mA
		X			Return/Exhaust Fan Cap Command	0-10 VDC
X7		X			Building Static Pressure (BPS)	4-20mA
		X			Return Air Fan Duct Static Pressure (RAFDPS)	4-20mA
				X	SCR	1-10 VDC
X8		X			Return Air Temperature	10K Thermistor Coefs/ InputType = 7
		X			OA Damper Input	0-10 VDC
X9		X			Discharge Air Temperature	10K Thermistor Coefs/(InputType = 7
X10		X			Outdoor Air Temperature	10K Thermistor Coefs/InputType = 7
X11		X			Entering Fan/Leaving Cooling Coil Temperature	10K Thermistor Coefs/InputType = 7)
Digital Inputs – Dry Contacts						
#					Point	Comments
DI1					Emergency Off (Fault/Normal)	
					Alarm Reset Input	Dry Contact
DI2					Fan Interlock Input	Dry Contact
					Compressor System Protection Interlock Input	Dry Contact
Digital Inputs – 24V						
#					Point	Comments
DI3					RemoteSwitch (Stop/Start)	
					HeatCool Command Input	
DI4					Passive Ventilation Input	
DI4					Emergency Off (Fault/Normal)	

<b>Digital Inputs – 115V</b>		
<b>#</b>	<b>Point</b>	<b>Comments</b>
DI5	DHL (Fault/Normal)	
DI6	Filter Switch Input 1 (Main Filter Section)	
<b>Digital Outputs – Relay (SPST, Normally Open, 230 VAC 3 Amp)</b>		
<b>#</b>	<b>Point</b>	<b>Comments</b>
DO1	Local/Remote Status Output	
DO2	Not Used	
DO3	Aux. Defrost Heater	
DO4	Defrost Status Not Used	
DO5	Heat (On/Off)	
	Heat Stage 1	
DO6	Heat Stage 2	
DO7	Heat Stage 3	
DO8	Heat Stage 4	
<b>Digital Outputs – Solid State Relays, 24-230 VAC, 0.5 A</b>		
<b>#</b>	<b>Point</b>	<b>Comments</b>
DO9	Alarm	
DO10	Auxiliary Output	
<b>EEV Drivers</b>		
<b>#</b>	<b>Point</b>	<b>Comments</b>
EV1	MHGRH Valve 1	Sporlan 3-Way Valve: <ul style="list-style-type: none"> <li>• 200 Steps/second</li> <li>• Bipolar</li> <li>• 6386 steps</li> <li>• 160mA current</li> <li>• No holding current</li> <li>• 0 overdrive open steps</li> <li>• 639 overdrive close steps</li> <li>• DeadTimeSync</li> </ul>
EV2	Not Used	

## Expansion Module A I/O (POL965 or POL96E/U)

POL96 module will be used when the unit is equipped with analog Space Temperature Sensor 3 (SpaceTCfg is 3AI) Otherwise, POL965 will be used.

**Table 66: Expansion Module A I/O (Main Control Panel)**

Universal Inputs/Outputs						
#	DI	AI	DO	AO	Point	Comments
X1				X	Chilled Water Valve	2-10 VDC
X2		X			RA Humidity Sensor	4-20 mA
X3		X			OA Humidity Sensor	4-20 mA
X4		X			OAFLOW Input	0-10VDC or 4-20 mA
X5	X				OADPosSw (Open/Closed)	Dry Contact
X6		X			Supply Air Temp Leaving Wheel (ER_LWT)	10K Thermistor Coefs/ InputType = 7
X7		X			Exhaust Air Temp Exiting Wheel (ER_EWT)	10K Thermistor Coefs/ InputType = 7
X8		X			Space Humidity Sensor 21	0-10 VDC or 4-20 mA
X9		X			Space Temperature Sensor 3	10K Thermistor Coefs/ InputType = 7
X10					Not Used	
X11					Not Used	
X12					Not Used	
Digital Input – 115V-230V						
#	DI	AI	DO	AO	Point	Comments
D11					Freezestat	
Digital Inputs – Dry Contacts						
#	DI	AI	DO	AO	Point	Comments
D11					Not Used	
D12					Not Used	
D13					Not Used	
Digital Outputs – Relay (SPST, Normally Open, 230 VAC 3 Amp)						
#	DI	AI	DO	AO	Point	Comments
DO1					Energy Recovery Wheel On/Off	Energy Recovery
DO2					Bypass Damper Closed	Energy Recovery
DO3					Bypass Damper Open	Energy Recovery
DO4					Not Used	
Digital Outputs – Solid State Relays, 24-230 VAC, 0.5 A						
#	DI	AI	DO	AO	Point	Comments
DO5					Not Used	
DO6					Not Used	
EV Drivers						
#	DI	AI	DO	AO	Point	Comments
EV1					Not Used	
EV2					Not Used	



## Expansion Module B I/O (POL965)

Table 67: Expansion Module B I/O (Main Control Panel)

Universal Inputs/Outputs						
#	DI	AI	DO	AO	Point	Comments
X1	X	X			Configurable Input 1	DI/AI/NTC
X2	X	X			Configurable Input 2	DI/AI/NTC
X3	X	X			Configurable Input 3	DI/AI/NTC
X4	X	X			Configurable Input 4	DI/AI/NTC
X5	X	X			Configurable Input 5	DI/AI/NTC
X6	X	X			Configurable Input 6	DI/AI/NTC
X7	X	X			Configurable Input 7	DI/AI/NTC
X8	X	X			Configurable Input 8	DI/AI/NTC
X9					Not Used	
X10					Not Used	
X11					Not Used	
X1 2					Not Used	
Digital Input – 115V-230V						
#					Point	Comments
D11					Not Used	
D14					Not Used	
Digital Inputs – Dry Contacts						
#					Point	Comments
D11					Not Used	
D12					Not Used	
D13					Not Used	
Digital Outputs – Relay (SPST, Normally Open, 230 VAC 3 Amp)						
#					Point	Comments
DO1					Generic BO1	
DO2					Generic BO2	
DO3					Generic BO3	
DO4					Generic BO4	
Digital Outputs – Solid State Relays, 24-230 VAC, 0.5 A						
#					Point	Comments
DO5					Generic BO5	
DO6					Generic BO6	

## Expansion Module E I/O (POL96E/U or POL98U)

POL98 module will be used when the unit is equipped with R32 refrigerant (Refrig Type is R32, R32HP,R32HP75, R32HP50, R32HP25 or R32HP0). Otherwise, POL96 will be used.

**Table 68: Expansion Module E I/O (Refrigeration Circuit 1)**

Analog Inputs –NTC						
AI1					Not Used	
AI2					Not Used	
AI3					Not Used	
Universal Inputs/Outputs						
#	DI	AI	DO	AO	Point	Comments
X1		X			VCmp 1 Body Temperature	50K Thermistor Coefs/InputType = 8
X2		X			Discharge Refrigerant Pressure 1	0.5-4.5VDC 0-700psi
X3		X			VFD Compressor 1 Discharge Line Temperature (DRT1)	50K Thermistor Coefs/InputType = 8
X4				X	DX Bypass Damper	0-10 VDC
X4				X	OA Damper	0-10 VDC
X5		X				
X6		X			Suction Refrigerant Pressure 1	0.5-4.5VDC 0-350psi
X7		X			Defrost Temperature 1 (DFT1)	10K Thermistor Coefs/InputType = 7
X8		X				
X9		X			VFD Compressor 1 Suction Refrigerant Temperature	10K Thermistor Coefs/ InputType = 7
X10		X			Liquid Line Refrigerant Temperature 1	10K Thermistor Coefs/ InputType = 7
X11						
X12						
Digital Input – 115V-230V						
#					Point	Comments
D11						
D14					High Pressure 1 (High/Normal)	
Digital Inputs – Dry Contacts						
#					Point	Comments
D11					Condensate Drainpan Overflow	
D12						
D13						
Digital Outputs – Relay (SPST, Normally Open, 230 VAC 3 Amp)						
#					Point	Comments
DO1					VCmp1 Board Enable	
DO2					VCmp1 Crankcase heater (CCH1)	
DO3					C1:Cond Solenoid 1	
DO4						
POL98E/U						
Digital Outputs – Relay (SPST, Normally Open, 230 VAC 3 Amp)						

#	Point	Comments
DO5	4 Way Valve 1 (4WV1)	
DO6	Reheat Bleed Valve	
<b>Digital Outputs – Relay (SPST, Normally Open, 230 VAC 3 Amp)</b>		
#	Point	Comments
DO7	Not Used	
DO8	Not Used	
<b>Digital Outputs – Solid State Relays, 24-230 VAC, 0.5 A</b>		
#	Point	Comments
DO9	Not Used	
DO10	Not Used	
<b>EV Drivers</b>		
#	Point	Comments
EV1	C1EV11	
EV2	MHGRH Valve 1	Sporlan 3-Way Valve: <ul style="list-style-type: none"> <li>• 200 Steps/second</li> <li>• Bipolar</li> <li>• 6386 steps</li> <li>• 160mA current</li> <li>• No holding current</li> <li>• 0 overdrive open steps</li> <li>• 639 overdrive close steps</li> <li>• DeadTimeSync</li> </ul>

## Expansion Module H I/O (POL965)

Table 69: Expansion Module H I/O (Return/Outdoor Panel)

Universal Inputs/Outputs						
#	DI	AI	DO	AO	Point	Comments
X1				X	Energy Recovery SCR Preheat	1-10VDC
X2		X			Space Humidity Sensor 2	0-10 VDC or 4-20 mA
X3		X			Space Temperature Sensor 2	10K Thermistor Coefs/ InputType = 7
X4				X	Relief Dampers	0-10 VDC
X5		X			SAF Flow Input	4-20 mA
X6		X			RFEF Flow Input	0-10VDC or 4-20 mA
X7		X			Filter Transducer 1 (Main Filter Section)	4-20mA
X8		X			Filter Transducer 2 (Main Filter Section)	4-20mA
Digital Input – 115V-230V						
#	DI	AI	DO	AO	Point	Comments
DI1					Filter Switch Input 2 (Final Filter Section)	
Digital Outputs – Relay (SPST, Normally Open, 230 VAC 3 Amp)						
#	DI	AI	DO	AO	Point	Comments
DO1					Positive Rel Damper Closure	
DO2					Econo Operation Signal	
DO3					Not Used	
DO4					Not Used	
Digital Outputs – Solid State Relays, 24-230 VAC, 0.5 A						
#	DI	AI	DO	AO	Point	Comments
DO5					Not Used	
DO6					Not Used	

## Expansion Model J I/O (POL965)

Table 70: Expansion Module J I/O (Main Control Panel)

Universal Inputs/Outputs						
#	DI	AI	DO	AO	Point	Comments
X1				X	SAF Capacity Command	0-10VDC
X2		X			SAF Capacity Feedback	0-10VDC or 4-20mA fro VFD
X3				X	RFEF Capacity Command	0-10VDC
X4		X			RFEF Capacity Feedback	0-10VDC or 4-20mA fro VFD
X5	X				SAF Status Input (Fault/OK)	Digital Input from VFD
X6	X				RFEF Status Input (Fault/OK)	Digital Input from VFD
X7					Not Used	
X8					Not Used	
X9					Not Used	
X10					Not Used	
X11					Not Used	
X1 2					Not Used	
Digital Input – 115V-230V						
#					Point	Comments
D11					Not Used	
D14					Not Used	
Digital Inputs – Dry Contacts						
#					Point	Comments
D11					Not Used	
D14					Not Used	
Digital Outputs – Relay (SPST, Normally Open, 230 VAC 3 Amp)						
#					Point	Comments
DO1					SAF VFD On/Off	
DO2					RF/EFF VFD On/Off	
DO3					Not Used	
DO4					Not Used	
Digital Outputs – Solid State Relays, 24-230 VAC, 0.5 A						
#					Point	Comments
DO5					Not Used	
DO6					Not Used	

## Universal I/O, Digital Input Status, Digital Output Status

**Table 71: Main Menu \ Service Menus \ Digital Input Status**

Menu Display Name	Default	Range	Description
DIGITAL INPUT STATUS: MCB, EMA, EMB, EMC, EMD, EME, EMF, EMG, EMH, EMI, EMJ, EMK, EML, EMM			
DI1...DI6	Off	Off On	Displays the current Digital Input status for each DI point

**Table 72: Main Menu \ Service Menus \ Digital Output Status**

Menu Display Name	Default	Range	Description
DIGITAL OUTPUT STATUS: MCB, EMA, EMB, EMC, EMD, EME, EMF, EMG, EMH, EMI, EMJ, EMK, EML, EMM			
DO1...DO6	Off	Off On	Displays the current Digital Output status for each DO point

## Network Input Status

**Table 73: Main Menu \ Service Menus \ Network Input Status**

Menu Display Name	Default	Range
Net OAT In	-	-50.0-200.0°F
Net SpaceT In	-	-0.0-150.0°F
NetCurrState	-	Occ Unocc TntOvrd Standby NUL
NetNextState	-	Occ Unocc TntOvrd Standby NUL
NetTmToNxtSt	-	0-65534min
Net App Mode	-	Off HeatOnly CoolOnly FanOnly Auto NA
Net CI Ena S	-	-1.0-1.0
Net CI Ena V	-	0-255%
Net HT Ena S	-	-1.0-1.0
Net Ht Ena V	-	0-255%
Net Ec Ena S	-	-1.0-1.0
Net Ec Ena V	-	0-255%
Net SAF Cap	-	0-100%

Menu Display Name	Default	Range
Net EF Cap	-	0-100%
Net Space PPM	-	0-5000ppm
Net Rel Humid	-	0-100%
Net DATClg Spt	-	40.0-100.0°F
Net DATHtgSpt	-	40.0-140.0°F 40.0-105.0°F
NetLCTSpt	-	45.0-65.0°F
NetDXBPLCTSpt	-	45.0-65.0°F
NetDemandShed	-	Inactive Auto Manual
nviSetpoint	-	0.0-100.0°F
NetOccManCmd	-	Occ Unocc TntOvrd Standby Auto
Net Min OA	-	0-100%
nvoEffSpt	-	0.0-100.0°F
nciOccClgSpt	-	0.0-100.0°F
nciOccHtgSpt	-	0.0-100.0°F
nciHVACType	-	Generic FanCoil VAV Hpump RTU UV ChilCeil Rad AHU SCU

## Modbus Status

**Table 74: Main Menu \ Service Menus \ Modbus Status**

Menu Display Name	Default	Range	Description
SAF1 MB Status	-	Fault OK	SAF1 MB Status is a status only item that displays the current Modbus Device Status
EF1 MB Status	-	Fault OK	EF1 MB Status is a status only item that displays the current Modbus Device Status
EF2 MB Status	-	Fault OK	EF2 MB Status is a status only item that displays the current Modbus Device Status
EF3 MB Status	-	Fault OK	EF3 MB Status is a status only item that displays the current Modbus Device Status
EF4 MB Status	-	Fault OK	EF4 MB Status is a status only item that displays the current Modbus Device Status
ER MB Status	-	Fault OK	ER MB Status is a status only item that displays the current Modbus Device Status
OAF1 MB Status	-	Fault OK	OAF1 MB Status is a status only item that displays the current Modbus Device Status
OAF2 MB Status	-	Fault OK	OAF2 MB Status is a status only item that displays the current Modbus Device Status
Fgas1 MB Status	-	Fault OK	A status only item that displays the current Modbus status for the staged furnace board 1
Fgas2 MB Status	-	Fault OK	A status only item that displays the current Modbus status for the staged furnace board 2
Fgas3 MB Status	-	Fault OK	A status only item that displays the current Modbus status for the staged furnace board 3
MGas MB Status	-	Fault OK	MGas MB Status is a status only item that displays the current Modbus Device Status
IFB MB Status	-	Fault OK	A status only item that displays the current Modbus status for the Interface Board
VCmp1 MB Status	-	Fault OK	VCmp1 MB Status is a status only item that displays the current Modbus Device Status
A2L MB Status	-	Fault OK	A status only item that displays the current Modbus status for the A2L leak detection board
PwrMtrMBStatus	-	No Com Comm	PwrMtrMBStatus is a status only item that displays the current Modbus Device Status
MB Resistance	-	No Pol1 Pol2 Pol12 Term2 T2P1 T2P2 T2P1P2	MB Resistance is a status only item that displays the current MB Resistance State



Menu Display Name	Default	Range	Description
Default Type	-	NA EBM Delta	An adjustable item that allows the selection of the fan type to be controlled by Modbus.
DefaultECMSts	-	Fault OK	DefaultECMSts is a status only item that displays the current Modbus Device Status.
ECM Chg From	Default	Default SAFM1 SAFM2 SAFM3 SAFM4 EFM1 EFM2 EFM3 EFM4	ECM Chg From is an adjustable item that sets which master fan address will be changed from during the field addressing process.
ECM Chg To	Default	Default SAFM1 SAFM2 SAFM3 SAFM4 EFM1 EFM2 EFM3 EFM4	ECM Chg To is an adjustable item that sets which master fan address will be changed to during the field addressing process.
ECM Cfg	Done	Done ApplChg	ECM Cfg is an adjustable item that applies an ECM Master Address configuration change.

# Advanced Operation

## Unit Configuration

**WARNING**

Operational settings should only be made with the advisement of a qualified person; changing key configurations away from factory settings may result in damage to equipment or surrounding property. Recommended settings may vary based on application specific requirements.

### Unit Configuration String

After the main control board application software is loaded into the MCB, it must be “configured” for the specific control application. This consists of setting the value of 30 configuration variables within the MCB. These variables define things such as the type of cooling, number of compressors, cooling stages, and the type of heat. If all of these items are not set appropriately for the specific unit, the unit will not function properly. The correct settings for these parameters are defined for a given unit by the unit “Software Configuration Code.”

The “Software Configuration Code” consists of a 30-character string of numbers and letters. The code can be found on the unit software Identification label located on the back side of the control panel door.

The table below lists the configuration code variables, including the position within the code, description of the parameter, and the applicable settings for each. The default values are shown in bold font. The unit is configured at the factory however may also be configured in the field by accessing the **Unit Configuration** menu. Once changes have been made to the Unit Configuration menu, the Apply Changes flag must be changed from no to yes in order for the controller to recognize the changes. Setting the Apply Changes Flag to Yes will automatically reset the controller.

**Table 75: Main Menu \ Service Menus \ Modbus Status**

Configuration Code Position	Description	Values	Notes
1	Control Type	0= Zone Temperature Control (ZTC)	
		1= Discharge Temperature Control (DTC)	
		2= Single Zone VAV Control (1ZnVAV)	
		3= Refrigeration Only Control - Fans/ Comps Via MT4 (RO_FC)	
		4= Refrigeration Only Control - Fans/ Comps/GasHt/ElecHt Via MT4 (RO_FCGE)	
2	Fixed Compressors	0-6	
3	Variable Compressors	0-4	
4	Compressor Circuits	0-3	
5	OAFanCfg	0=None	
		1=OnOffT	
		2= OnOffP	
		3=VarVFD	
		4=VarECM1	
		5=VarECM2	
		6=VarDK1	
		7=VarDK2	
		8=AnlgMB1	
9=AnlgMB2			

Configuration Code Position	Description	Values	Notes
6	Damper Type	0=None	
		1=Single Position 0-30% (30OA)	
		2=Single Position 100% (100OA)	
		3=Modulating Economizer Air side (Econ)	
		4= Modulating Economizer Air side with FDD (EconFDD)	
		5=Single Position 100% with Recirc (100wRec)	
7	Heating Type	0=None	
		1=F&BP Control (F&BP)	
		2=Steam or Hot Water (HW_Stm)	
		3=Modulated Gas, 5-1 (M1G5-1) (was L200)	
		4=Modulated Gas, 5-1 (M1G5-1) (was L400)	
		5=Modulated Gas, 5-1 (M1G5-1) (was L600)	
		6=Modulated Gas, 10-1 (M1G10-1) (was H400)	
		7=Modulated Gas, 10-1 (M1G10-1) (was H600)	
		8=Modulated Gas, 10-1 (M2G10-1) (was L800)	
		9=Modulated Gas, 10-1 (M3G10-1) (was L1200)	
		A=Modulated Gas, 20-1 (M2G20-1) (was H800)	
		B=Modulated Gas, 20-1 (M3G20-1) (was H1200)	
		C=2 Stage Electric (2StgE)	
		D=2 Stage Gas (2StgG)	
		E=4 Stage Electric (4StgE)	
		F=4 Stage Gas (4StgG)	
		G=SCR Electric (SCR)	
		H=SCR Electric/Supplemental Reheat (SCRSh)	
I=Not Used			
J=Modulating Gas, 20-1 (M4G10-1)			
K= Modulating Gas, 40-1 (M4G20-1)			
L=Modulating Gas, 12-1 (M1G12-1)			
8,9,10	Max Heat Rise	Three Digits (Default = 100, Range 0-100)	

Configuration Code Position	Description	Values	Notes
11	SAFType	0=Analog1 (Anlg1)	
		1=1 ECM Modbus Master Fan (1M)	
		2=2 ECM Modbus Master Fans (2M)	
		3=3 ECM Modbus Master Fans (3M)	
		4=4 ECM Modbus Master Fans (4M)	
		5= 6 ECM Modbus Master Fans (6M)	
		6=Analog1MB (AnlgMB1)	
		7=Analog2MB (AnlgMB2)	
		8=Analog3MB (AnlgMB3)	
12	EFType	0=None	
		1=RF Analog1 (RFAnlg1)	
		2=EF Analog1 (EFAnlg1)	
		7= 1 ECM Modbus Exhaust Fan (1ECMEF)	
		8= 2 ECM Modbus Exhaust Fans (2ECMEF)	
		9= 3 ECM Modbus Exhaust Fans (3ECMEF)	
		A= 6 ECM Modbus Exhaust Fans (6ECMEF)	
		C= Exhaust Fan VFD Modbus (EFVFDMB)	
		D=RF Analog1MB (RFAGMB1)	
		E=EF Analog1MB (EFAgMB1)	
		F=RF Analog2MB (RFAGMB2)	
		G=EF Analog2MB (EFAgMB2)	
		H=RF Analog3MB (RFAGMB3)	
		J=EF Analog3MB (EFAgMB3)	
13	ER Config	0=None	
		1=Constant Speed Wheel (CS)	
		2=Constant Speed Wheel w/ RH (CSRH)	
		3=NA	
		4=NA	
		5=VFD Modbus (VFD)	
		6=Analog (Anlg)	
14	Reheat Type	0=None	
		1=Primary Heat Reheat (PriHtg)	
		2=Primary Heat Reheat w/DXBP (PriHtBP)	
		3=Modulating Hot Gas (MHG)	
		4=Modulating Hot Gas w/DXBP (MHGBP)	
		7=DX Bypass Only (DXBP)	

Configuration Code Position	Description	Values	Notes
15	ExtOA Input	0=None	
		1=ExtVDC	
		2=ExtmA	
		3=CO2VDC	
		4=CO2mA	
		5=CO2QMX+	
		6=IAQMB	
16	OA Flow Input	0=None	
		1=VDC	
		2=mA	
17	SA Flow Input	0=None	
		1=1Fan	
		2=2Fan	
		3=3Fan	
		4=4Fan	
		5=6Fan	
		6=8Fan	
		7=9Fan	
		8=12Fan	
		9=16Fan	
18	EF Flow Input	0=None	
		1=1Fan	
		2=2Fan	
19	StaticPCfg	SAFSPS:EFSPS	
		0=NA:NA	
		1=DSP:NA	
		2=DSP:DSP	
		3=DSP:BSP	
		4=BSP:NA	
		5=NA:DSP	
6=NA:BSP			
20	SpaceTCfg	0=None	
		1=1 Sensors (1AI)	
		2=2 Sensors (2AI)	
		3=3 Sensors (3AI)	
		4=1 Sensors Space Temp Only (1QMXS)	
		5=2 Sensors Space Temp Only (2QMXS)	
		6=3 Sensors Space Temp Only (3QMXS)	
		7=1 Sensors Space/Hum/CO2 (1QMX+)	
		8=2 Sensors Space/Hum/CO2 (2QMX+)	
		9=3 Sensors Space/Hum/CO2 (3QMX+)	
		A=1 Sensor IAQ SpacMB (1IAQMB)	
21,22,23	Unit Size	Three digits (default 050, Range 0-999)	

Configuration Code Position	Description	Values	Notes
24	MonitorPkgs	0=None	
		1=Refrig System Only (RefSys)	
		2=Power Monitor (Pwr)	
		3=Refrig System and Power Monitor (Ref&Pwr)	
		4=IAQ (IAQ)	
		5=IAQ/Ref (IAQRef)	
		6=IAQ/Pwr (IAQPwr)	
		7=IAQ/Ref/Pwr (IAQRP)	
25	EHGBPCfg	0=None	
		1=Circ1	
26	Refrig Type	0=None	
		1=R410A (no heat pump)	
		2=R32 (no heat pump)	
		3=R32HP (heat pump no aux heat limit)	
		4=R32HP75 (heat pump 75% aux heat limit)	
		5=R32HP50 (heat pump 50% aux heat limit)	
		6=R32HP25 (heat pump 25% aux heat limit)	
		7=R32HP0 (heat pump 0% aux heat limit)	
27	Unit Voltage	0=208/60Hz	
		1=230/60Hz	
		2=460/60Hz	
		3=575/60Hz	
28	Preheat Type	0=None	
		1=HW_Stm	
		2=F&BP	

Configuration Code Position	Description	Values	Notes
29	EV Type	0=None	
		1=Danfoss ETS (DFETS)	
		2=Danfoss Colibri (DFCol)	
		3=Fujikoki_PAM 2000 (FJPAM2)	
		4=Fujikoki_PAM 3000 (FJPAM3)	
		5=Sporlan (Spln)	
		6=Fujikoki_PAM 3000/Fujikoki_PAM 2000 (Fj3/Fj2)	
		7=Danfoss Colibri/Fujikoki_PAM 2000 (DFC/Fj2)	
		8=Danfoss Colibri/Fujikoki_PAM 3000 (DFC/Fj3)	
		9=Sporlan/Fujikoki_PAM 2000 (Spr/Fj2)	
		A=Sporlan/Fujikoki_PAM 3000 (Spr/Fj3)	
		B=Sporlan/Danfoss Colibri (Spr/DFC)	
		C=Fujikoki_PAM 2000/Sporlan (Fj2/Spr)	
		D=Fujikoki_PAM 3000/Sporlan (Fj3/Spr)	
E= Danfoss Colibri/Sporlan (DFC/Spr)			
30	IOConfig	0=RebApp	
		1=Rebel	
31	Sensor Cfg	0-8	

## Unit Set-Up

### Rapid Start Operation

The user may elect to initiate a **Rapid Start** sequence at unit power up by setting the rapid start flag to Yes. When this flag is set to Yes, the Rapid Start timer and Service Timer is set to 10 min whenever the power is reset to the controller. When the service timer is not zero, the times for the Cooling Stage Time, Heating Stage Time, Start Initial Time, Recirculation Time, and ZeroOATime are set to the Service time value (SrvcTime Inc = default 30s) instead of running through the normal values. This allows the unit to be run through its operating states without having to wait for the normal time delays to expire. These times revert to the standard values when the Service Timer Count Down is zero.

**Table 76: Main Menu \ Advanced Menu \ Unit Set-Up**

Menu Display Name	Default	Range	Description
Rapid Start	No	No Yes	Rapid Start is an adjustable item that allows the user to select to initiate a rapid startup sequence at unit power up.
Rapid Start Tm	10min	0-20 min	Rapid Start Tm is an adjustable item that allows the user to set the Rapid Start timing whenever the power is reset to the controller and the controller finishes its startup sequence.
Aux Out Cfg	FanOp	FanOp VAVBox	Aux Out Cfg is an adjustable item that defines the functional it of the digital output (DO10) on the main control board. The output is either a supply fan operation output indication or a VAV box signal depending on how this parameter is set.

### Advanced Timers



#### WARNING

Operational settings should only be made with the advisement of a qualified person; changing key configurations away from factory settings may result in damage to equipment or surrounding property. Recommended settings may vary based on application specific requirements.

**Table 77: Main Menu \ Advanced Menu \ Advanced Timers**

Menu Display Name	Default	Range	Description
Pwd Timeout	10min	3-720min	Pwd Timeout is an adjustable item that sets the amount of time in minutes that the controller will allow access to applicable menus without re-entering the necessary password. If the keypad display remains idle for this time period the display will revert to the "main menu" requiring a re-entering of the password.
Airflow Ign	120s	0-999s	Air Flw Ign is an adjustable item that sets the amount of time the air proving signal from the fans is ignored after the supply fan is started.
Htg WrmupTm	45s	0-45s	-
Htg HldPeriod	240s	0-999s	HtgHldPeriod is an adjustable item which is used to set the amount of time the gas heating valve remains at its calculated value on units equipped as 100% OA (default 240s). This is to allow the temperature to approach equilibrium with the modulating gas heating valve at a fixed position.



Menu Display Name	Default	Range	Description
Srvc Time Inc	30s	30-300s	Srvc Time Inc is an adjustable item used to set the internal stage time delay when the Aux is not zero, the times listed below are to set to the Service Time (Default = 30s) instead of the normal values. <ul style="list-style-type: none"> <li>• Cooling Stage Timer</li> <li>• Heating Stage Timer</li> <li>• Start Initial Timer</li> <li>• Recirculation</li> <li>• Zero OA Timer</li> </ul>
OffHtCIDelay	120s	0-999s	OffHtCIDelay is an adjustable item that sets a delay in turning off the supply air fan when the unit is shut off while cooling or heating operation is active.
MinExStartTm	120s	60-300s	MinExStartTm is an adjustable item that sets the minimum exhaust fan on time (Default = 120 seconds).
MinExStopTm	120s	60-300s	MinExStopTm is an adjustable item that sets the minimum exhaust fan stop time (Default = 120 seconds).
ERWhl Stg Tm	5min	1-100min	ERWhl Stg Tm is an adjustable item used to set a minimum time period for operating at either the minimum or maximum speed before action is taken to change speed during the frost protect mode of operation.
ERWhl Off Tm	20min	1-100min	ERWhl Off Tm is an adjustable item used to set the minimum amount of time the energy wheel will remain off after being turned off due to a frosting/condensation condition.
SAF Ctrl Dly	60s	60-300s	SAF Ctrl Dly is an adjustable item that sets the duration of time that the minimum speed signal is sent to the variable speed supply air fan after the supply fan is started via a modbus or digital output. Control reverts to either duct pressure or speed after the fan has been on for the SAF CtrlDelay (default 30 seconds).
EF Ctrl Dly	60s	60-300s	EF Ctrl Dly is an adjustable item that sets the duration of time that the minimum speed signal is sent to the variable speed exhaust air fan after the exhaust fan is started via a modbus or digital output. Control reverts to either duct pressure or speed after the fan has been on for the SAF CtrlDelay (default 30 seconds).
Frz Delay Tm	30s	0-180s	Frz Delay Tm is an adjustable item that is used to set the freeze alarm delay time.
LP Delay	2s	0-10s	LP Delay is an adjustable item used to set the low pressure switch delay time.
LP Comp Delay	5s	0-60s	LP Comp Delay is an adjustable item that is used to set the low pressure compressor delay time.
Sens Alm Dly	30s	0-300s	Sens Alm Dly is an adjustable item that is used to set the sensor alarm delay time.
Tmp Alm Dly	35s	0-300s	Tmp Alm Dly is an adjustable item is an adjustable item used to set the temperature alarm delay time.

# Supply Fans

## SAF Set-Up

Table 78: Main Menu \ Advanced Menu \ SAF Set-Up

Menu Display Name	Default	Range	Description
SAF Ctrl Dly	60s	0-300s	SAF Ctrl Dly is an adjustable item that sets the duration of time that the minimum speed signal is sent to the variable speed supply air fan after the supply fan is started via a modbus or digital output. Control reverts to either duct pressure or speed after the fan has been on for the SAF CtrlDelay (default 30 seconds).
SAFCtrlDlyCap	25.0%	0-100.0%	SAFCtrlDlyCap is an adjustable item that sets the capacity that the fan will stay during the SAF Ctrl Dly Timer.
HtgClgOffCap	33.0%	33.0-100.0%	HtgClgOffCap is an adjustable item that sets the capacity the supply fan will operate at when the unit state is off but the fan is running due to the Htg/ClgOffDelay being true or if an compressorized cooling circuit state is Pumpdown.
SAFVentCap	0%	0-100%	SAFVentCap is an adjustable item that sets the supply fan speed with the external ventilation override input to the supply fan is present.
SAFIncTime	60s	0-999s	SAFIncTime is an adjustable value used to set the time it takes for the supply air fan to ramp from off to 100% speed.
SAFDecTime	60s	0-999s	SAFDecTime is an adjustable value used to set the time it takes for the supply air fan to ramp from 100% speed to off.
AgSAFStrtCap	75%	50-100%	AgSAFStrtCap is an adjustable item used in specific indoor agriculture applications. This item is used to set the supply fan starting speed.
AgSAFChgInc	5%	1-20%	AgSAFChgInc is an adjustable item used in specific indoor agriculture applications. This item is used to set the supply fan percentage change in speed.
AgSAFChgTm	20min	10-60min	AgSAFChgTm is an adjustable item used in specific indoor agriculture applications. This item is used to set the timer flag which is used when measuring the time since the supply fan speed has changed.
AgSAFRstChg	3°F	2-10°F	AgSAFRstChg is an adjustable item used in specific indoor agriculture applications. This item is used to set the value by which the occupied cooling set point changes in order to change the supply fan command to the Start Capacity.
SAF1-SAF6 Type	NA	NA EBM Delta	An adjustable item to select the number of Supply Air Fans.
Fan P/N	-	*****	Fan P/N is a status only item that indicates the supply fan part number.
Fan Size	630 (default read and established via Modbus)	000-999	An adjustable item to select the Supply Air Fan diameter.
KVal Ovr	0	000-999	An adjustable item to enter a piezo ring K-Value which will override existing value.
SAFCapInType	VDC	VDC mA	SAFCapInType is the signal input type for units with analog controlled fans.
SAFCapMinSig	0.0V	0.0-20.0 V/mA	SAFCapMinSig is the minimum signal input corresponding to 0% fan capacity for units with analog controlled fans.
SAFCapMaxSig	10.0V	0.0-20.0 V/mA	SAFCapMaxSig is the maximum signal input corresponding to 100% fan capacity for units with analog controlled fans.

## SAF DSP Control

**Table 79: Main Menu \ Advanced Menu \ SAF Set-Up \ DSP Control**

Menu Display Name	Default	Range	Description
SAF Ramp Time	60s	0-999s	SAF Ramp Time is an adjustable item that sets the amount of time it will take for the variable speed fan to drive from its minimum to maximum speed as well as its maximum to minimum speed. The SAF Ramp Time= value on the keypad must be changed whenever the ramp time of the variable speed fan is changed. The ramp up time must equal the ramp down time, and both must equal the SAF RampTime value to provide stable operation.
Min SAF Period	5s	0-999s	Min SAF Period is an adjustable item that sets the duration of the sample time between speed changes. The sample time must be long enough to allow the static pressure to get very close to its steady state value before another calculation is made.
Max SAF Chg	15%	0-100%	Max SAF Chg is an adjustable item that sets the maximum value for a speed increase or decrease (either positive or negative value) is added to the current fan speed whenever the control set point (example duct pressure) is outside of the deadband and the Min Period time has passed since the last speed change.

## 1 Zone VAV Control

**Table 80: Main Menu \ Advanced Menu \ SAF Set-Up \ 1ZnVAV Control**

Menu Display Name	Default	Range	Description
1ZnVAV Period	60s	0-999s	1ZnVAV Period is an adjustable item that sets the "sampling time" used in the PI control function to vary the supply fan speed when 1ZnVAV supply fan control is selected.
1ZnVAV Gain	0.8	0.0-100.0s	1ZnVAV Gain is an adjustable item that sets the "gain" used in the PI control function to vary the supply fan speed when 1ZnVAV supply fan control is selected.
1ZnVAV PAT	400s	0-999s	1ZnVAV PAT is an adjustable item that sets the "project ahead time" used in the PI control function to vary the supply fan speed when 1ZnVAV supply fan control is selected.
1ZnVAVMax Chg	10%	0-100%	1ZnVAVMax Chg is an adjustable item that sets the maximum value of increase or decrease of the supply fan speed each period used in the PI control function to vary the supply fan speed when 1ZnVAV supply fan control is selected.

## OAFLOW Control

**Table 81: Main Menu \ Advanced Menu \ SAF Set-Up \ OAFLOW Control**

Menu Display Name	Default	Range	Description
Min OA Flow	0CFM	0-60000CFM	Min OA Flow is an adjustable item that sets the minimum CFM value of the airflow station input signal.
Max OA Flow	10000CFM	0-60000CFM	Max OA Flow is an adjustable item that sets the maximum CFM value of the airflow station input signal.
V/A@MinOAFIw	0.0/V	0.0-20.0V/mA	V/A@MinOAFIw is an adjustable item that sets the DC voltage or mA value at the minimum CFM value of the airflow station input signal.
V/A@MaxOAFIw	10.0/V	0.0-20.0V/mA	V/A@MaxOAFIw is an adjustable item that sets the DC voltage or mA value at the maximum CFM value of the airflow station input signal.
Flow DB	3%	0-100%	Flow DB is an adjustable item that sets the “deadband” used in the PI control function to vary the supply fan speed when airflow (CFM) supply fan control is selected.
Flw Period	30s	0-999s	Flow Period is an adjustable item that sets the “sample time” used in the PI control function to vary the supply fan speed when airflow (CFM) supply fan control is selected.
Flw Gain	0.1	0.0-100.0	Flow Gain is an adjustable item that sets the “gain” used in the PI control function to vary the supply fan speed when airflow (CFM) supply fan control is selected.
Flow MaxChg	5%	0-100%	Flow MxChg is an adjustable item that sets the maximum value of increase or decrease of the supply fan speed each period used in the PI control function to vary the supply fan speed when airflow (CFM) supply fan control is selected.

## SAF FLOW Control

**Table 82: Main Menu \ Advanced Menu \ SAF Set-Up \ SAF FLOW Control**

Menu Display Name	Default	Range	Description
Flow DB	3%	0-100%	Flow DB is an adjustable item that sets the “deadband” used in the PI control function to vary the supply fan speed when airflow (CFM) supply fan control is selected.
Flow Period	30s	0-999s	Flow Period is an adjustable item that sets the “sample time” used in the PI control function to vary the supply fan speed when airflow (CFM) supply fan control is selected.
Flow Gain	0.1	0.0-100.0	Flow Gain is an adjustable item that sets the “gain” used in the PI control function to vary the supply fan speed when airflow (CFM) supply fan control is selected.
Flow MxChg	5%	0-100%	Flow MxChg is an adjustable item that sets the maximum value of increase or decrease of the supply fan speed each period used in the PI control function to vary the supply fan speed when airflow (CFM) supply fan control is selected.

## SAF BSP Control

**Table 83: Main Menu \ Advanced Menu \ SAF Set-Up \ SAF BSP Control**

Menu Display Name	Default	Range	Description
BSP Period	5s	0-999s	BSP Period is an adjustable item that sets the “sample time” used in the PI control function to vary the supply fan speed when building static pressure (BSP) supply fan control is selected.
BSP Gain	0.2	0.0-100.0	BSP Gain is an adjustable item that sets the “gain” used in the PI control function to vary the supply fan speed when building static pressure (BSP) supply fan control is selected.
BSP Max Chg	4%	0-100%	BSP Max Chg is an adjustable item that sets the maximum value of increase or decrease of the supply fan speed each period used in the PI control function to vary the supply fan speed when building static pressure (BSP) supply fan control is selected.

## Exhaust Fans

### EF Set-Up

**Table 84: Main Menu \ Advanced Menu \ EF Set-Up**

Menu Display Name	Default	Range	Description
EF Ctrl Dly	60s	0-999s	EF Ctrl Dly is an adjustable item that sets the duration of time that the minimum speed signal is sent to the variable speed exhaust air fan after the Exhaust fan is started via a modbus or digital output. Control reverts to either normal control type after the fan has been on for the SAF CtrlDelay (default 30 seconds).
EFVentCap	0%	0-100%	EFVentCap is an adjustable item that sets the exhaust fan speed with the external ventilation override input to the exhaust fan is present. Included with the Ventilation Override controls sequence.
MinExStrtTm	120s	60-300s	MinExStrtTm is an adjustable item that sets the minimum exhaust fan on time (default 120s).
MinExStopTm	120s	60-300s	MinExStopTm is an adjustable item that sets the minimum exhaust fan off time (default 120s).
EFIncTime	60s	0-999s	An adjustable item for the Exhaust Fan time it takes to go from off to full speed.
EFDecTime	60s	0-999s	An adjustable item for the Exhaust Fan time it takes to go from full speed to off.
EF1-6 Type	NA	NA EBM Delta	An adjustable item to select the type of Exhaust Fan Type.
EFCapInType	VDC	VDC mA	EFCapInType is the signal input type for units with analog controlled fans.
EFCapMinSig	0.0V	0.0-20.0 V/mA	EFCapMinSig is the minimum signal input corresponding to 0% fan capacity for units with analog controlled fans.
EFCapMaxSig	10.0V	0.0-20.0 V/mA	EFCapMaxSig is the maximum signal input corresponding to 100% fan capacity for units with analog controlled fans.
Fan P/N	-	*****	Fan P/N is a status only item that indicates the exhaust fan part number.

Menu Display Name	Default	Range	Description
Fan Size	630 (default read and established via Modbus)	000-999	An adjustable item to select the diameter of the Exhaust Fan.
KVal Ovrld	0	0-999	An adjustable item to enter a piezo ring K-Value which will override existing value.

## EF BSP Control

*Table 85: Main Menu \ Advanced Menu \ EF Set-Up \ EF BSP Control*

Menu Display Name	Default	Range	Description
BSP Period	5s	0-999s	BSP Period is an adjustable item that sets the “sample time” used in the PI control function to vary the exhaust fan capacity when building static pressure (BSP) EF control is selected.
BSP Gain	0.2	0.0-100.0	BSP Gain is an adjustable item that sets the “gain” used in the PI control function to vary the exhaust fan capacity when building static pressure (BSP) EF control is selected.
BSP Max Chg	4%	0-100%	BSP Max Chg is an adjustable item that sets the maximum value of increase or decrease of the exhaust fan capacity each period used in the PI control function to vary the exhaust fan capacity when building static pressure (BSP) EF control is selected.

## EF Flow Control

*Table 86: Main Menu \ Advanced Menu \ EF Set-Up \ EF DSP Control*

Menu Display Name	Default	Range	Description
EF FlwPeriod	30s	0-999s	EF FlwPeriod is an adjustable item that sets the “sample time” used in the PI control function to vary the exhaust fan capacity when EF Flw Control is selected.
EF Flw Gain	0.1	0.0-100.0	EF Flw Gain is an adjustable item that sets the “gain” used in the PI control function to vary the exhaust fan capacity when Exhaust Fan Flow Control is selected.
EF Flw PAT	60s	0-999s	EF Flw PAT is an adjustable item that sets the “project ahead time” used in the PI control function to vary the exhaust fan speed when EF Flow Control is selected.
EF Flw MxChg	5%	0-100%	EF Flw MxChg is an adjustable item that sets the maximum value of increase or decrease of the exhaust fan capacity each period used in the PI control function to vary the exhaust fan capacity when EF Flw Control) EF control is selected.

## Flow Diff Control

*Table 87: Main Menu \ Advanced Menu \ EF Set-Up \ Flow Diff Control*

Menu Display Name	Default	Range	Description
FlwDiff Period	30s	0-999s	FlwDiff Period is an adjustable item that sets the “sample time” used in the PI control function to vary the exhaust fan capacity when EF Flow Diff Control is selected.
FlwDiff Gain	0.1	0.0-100.0	FlwDiff Gain is an adjustable item that sets the “gain” used in the PI control function to vary the exhaust fan capacity when Exhaust Fan Flow Diff Control is selected.
FlwDiff PAT	60s	0-999s	FlwDiff PAT is an adjustable item that sets the “project ahead time” used in the PI control function to vary the exhaust fan speed when EF Flow Diff Control is selected.

Menu Display Name	Default	Range	Description
FlwDiff MxChg	5%	0-100%	FlwDiff MxChg is an adjustable item that sets the maximum value of increase or decrease of the exhaust fan capacity each period used in the PI control function to vary the exhaust fan capacity when EF Flw Diff Control EF control is selected.

## EF OAD Control

**Table 88: Main Menu \ Advanced Menu \ EF Set-Up \ EF OAD Control**

Menu Display Name	Default	Range	Description
ExhMinOAPos	5%	0-100%	ExhMinOAPos is an adjustable item that sets the OA position where the exhaust fan turns on when the EF control is set to Outdoor air damper.
ExhMinSAFCap	10%	0-100%	ExhMinSAFCap is an adjustable item that sets the minimum exhaust SAF capacity. The supply air fan speed must be higher than this value for exhaust operation.

## Heating and Cooling Change Over



### WARNING

Operational settings should only be made with the advisement of a qualified person; changing key configurations away from factory settings may result in damage to equipment or surrounding property. Recommended settings may vary based on application specific requirements.

### Project Ahead

This section describes the projected control temperature used to turn On and Off stages of heating and cooling for Zone Control units. It is not used for DAT control units.

In Zone Control cooling and heating operation, the Projected Control Temperature reduces overshoot as the zone temperature approaches a set point after start up. It does this by causing stages to stop increasing before the actual control temperature reaches the set point. The rate of change to the control temperature is calculated once per minute by the controller and equals the change during the last 60 seconds. This rate of change is multiplied by the Effective Project Ahead Time and is added to the current control temperature. The rate of change may be negative or positive, so the Projected Control Temperature may be higher or lower than the actual control temperature. This value, the Projected Control Temperature, is the temperature that would exist after the **Project Ahead** time passes if the control temperature were to continue to change at the same rate for the Effective Project Ahead Time. The Effective Project Ahead time is set equal to the Cooling Project Ahead Time when the unit is in the Cooling state. The Effective Project Ahead Time is set equal to the Heating Project Ahead time when in the Heating State. It is set equal to zero under all other conditions, causing the projected Control Temperature to equal the actual control temperature.



## HtgClg ChangOvr Set-up

Table 89: Main Menu \ Advanced Menu \ Htg/Clg ChngOvr Set-Up

Menu Display Name	Default	Range	Description
PA Ctrl Temp	-	-83.2-147.0°F	PA Ctrl Temp.
ClgSptPeriod	60s	0-999s	ClgSptPeriod is an adjustable item which sets the “sampling time” used in the PI control function to vary the DAT Clg Spt in zone control applications.
ClgSptGain	0.1	0.0-100.0	ClgSptGain is an adjustable item which sets the “gain” used in the PI control function to vary the DAT Clg Spt in zone control applications.
ClgSptPAT	600s	0.0-999s	ClgSptPAT is an adjustable item which sets the “project ahead time” used in the PI control function to vary the DAT Clg Spt in zone control applications.
MaxClgSptChg	5.0°F	0.0-50.0°F	MaxClgSptChg is an adjustable item that sets the maximum value for an increase or decrease of the DAT Clg Spt in zone control applications.
HtgSptPeriod	60s	0-999s	HtgSptPeriod is an adjustable item which sets the “sampling time” used in the PI control function to vary the DAT Htg Spt in zone control applications.
HtgSptGain	0.1	0.0-100.0	HtgSptGain is an adjustable item which sets the “gain” used in the PI control function to vary the DAT Htg Spt in zone control applications.
HtgSptPAT	600s	0.0-999s	HtgSptPAT is an adjustable item which sets the “project ahead time” used in the PI control function to vary the DAT Htg Spt in zone control applications.
MaxHtgSptChg	5.0°F	0.0-50.0°F	MaxHtgSptChg is an adjustable item that sets the maximum value for an increase or decrease of the DAT Htg Spt in zone control applications.
EcoSptPeriod	60s	0-999s	EcoSptPeriod is an adjustable item which sets the “sampling time” used in the PI control function to vary the DAT Econo Spt in zone control applications.
EcoSptGain	0.1	0.0-100.0	EcoSptGain is an adjustable item which sets the “gain” used in the PI control function to vary the DAT Econo Spt in zone control applications.
EcoSptPAT	600s	0.0-999s	EcoSptPAT is an adjustable item which sets the “project ahead time” used in the PI control function to vary the DAT Econo Spt in zone control applications.
MaxEcoSptChg	5.0°F	0.0-50.0°F	MaxEcoSptChg is an adjustable item that sets the maximum value for an increase or decrease of the DAT Econo Spt in zone control applications.
ClgDmdShdInc	4.0°F	0.0-10.0°F	An adjustable item to increase the occupied Cooling set point.
HtgDmdShdInc	4.0°F	0.0-10.0°F	An adjustable item to reduce the occupied Heating set point.
ClgShedRate	2.0°F/h	1.0-60.0°F/h	An adjustable item to set the rate at which the Cooling Shed increments.
HtgShedRate	2.0°F/h	1.0-60.0°F/h	An adjustable item to set the rate at which the Heating Shed increments.

## High Ambient Limiting

A Control Algorithm is included with the MicroTech that is intended to prevent nuisance high pressure trips during **High Ambient** excursions by staging down fixed speed compressor(s) to allow the unit to operate in a partial capacity state. This High Pressure Unloading protection can be disabled in the Cooling menu. Units that are equipped with Ambient based FanTrol will hold compressor staging (Up) if the OAT is greater than 115°F and will stage down a compressor if the OAT is greater than 118°F for five minutes. Units that are equipped with Pressure based FanTrol or SpeedTrol will hold compressor stage (Up) based on  $T_c > 140^\circ\text{F}$  for 30 seconds and will stage down when  $T_c > 148^\circ\text{F}$  for 30 seconds.

## SpeedTrol

Daikin Applied's **SpeedTrol** head pressure control operates by modulating the motor speed of all the condenser fans on their respective refrigeration circuit in response to the condenser pressure.

This option allows for mechanical cooling operation down to 25°F for the standard ambient package and -10°F (-23C) when equipped as a Low ambient unit. In a SpeedTrol equipped unit, MicroTech senses refrigerant head pressure and varies the condenser fan speed accordingly. When the pressure rises, the SpeedTrol increases the speed of the fan. When the pressure falls, SpeedTrol decreases the speed of the fan.

The VFD throttling range is 250 to 400 psig, fixed, with a corresponding fan speed range of 10Hz to 60Hz. The fan motor is a three-phase motor, identical to the unit voltage (208V to 575V) and is controlled by a variable frequency drive. The variable frequency drive receives a signal from the MicroTech, which reads a pressure transducer and varies the speed of the condenser fan accordingly. As condenser fan speed reaches its minimum, fans will be staged Off, or cycled to keep a minimum dead pressure of 250 psig.

## Cooling Set-Up

Table 90: Main Menu \ Advanced Menu \ Cooling Set-Up

Menu Display Name	Default	Range	Description
Lead Circuit	Circ1	Circ1 Auto	Lead Circuit is an adjustable item that sets which circuit is considered the lead circuit. If a unit is equipped with modulating hot gas reheat, Circuit 1 will always function as the lead circuit during dehumidification operation.
LoadMethod	CrossLoad	LeadLoad CrossLoad	LoadMethod is an adjustable item that sets if the compressors will be staged based on circuit.
DT Above Spt	-	0.0-250.0 F	DT Above Spt is a read only item.
DT Below Spt	-	0.0-250.0 F	DT Below Spt is a read only item.
HiOADwptValue	60°F	0-100°F	Adjustable value used to trigger a “High Dew point Cooling Fault”, which disables the entire unit. Applies only to DOAS units.
HiOADwptDiff	2.0°F	2-10°F	High Outside Air Dew point Differential is an adjustable value used with HIOADwptValue to trigger and clear alarm.
HiAmbLimiting	On	Off On	HiAmbLimiting is an adjustable item that sets if HiAmbinent Limiting turned on.
DXBP Period	60s	0-999s	DXBP Period is an adjustable item which sets the “sampling time” used in the PI control function to vary the DX BP damper.
DXBP Gain	0.8	0.0-100.0	DXBP Gain is an adjustable item which sets the “gain” used in the PI control function to vary the DX BP Damper.
DXBP PAT	120s	0-999s	DXBP PAT is an adjustable item which sets the “project ahead time” used in the PI control function to vary the DX BP Damper.
DXBP Max Chg	10%	0-100%	DXBP Max Chg is an adjustable item that sets the maximum value for an increase or decrease of the DXBP Damper Position.
Curr Clg Stg	-	0-8	Curr Clg Stg is a read only item that displays the current cooling stage.
<b>REFRIG CIRCUIT 1</b>			
PTS1	-	0-725psi	PTS1 is a status only item that displays the current suction line refrigerant pressure for circuit #1.
PTD1	-	0-725psi	PTD1 is a status only item that displays the current discharge line refrigerant pressure for circuit #1.
SSH1	-	-115-115°F	SSH1 is a status only item that displays the current suction super heat for circuit #1.
DSH1	-	-115-115°F	DSH1 is a status only item that displays the current discharge super heat for circuit # 1.
Tg1	-	-50.0-212.0°F	Te1 is a status only item that displays the circuit average suction pressure equivalent saturation temperature.
Tc1	-	-83-212°F	TC1 is a status only item that displays the circuit average discharge line pressure equivalent saturation temperature. Calculated from PTD1 using the standard ASHRAE conversion for R32.
C1DRT1	-	-83-212°F	A status only item which indicates the Discharge Temperature of Comp. 1 in Refrigerant Circuit 1.
C1DRT3	-	-83-392°F	A status only item which indicates the Discharge Temperature of Comp. 3 in Refrigerant Circuit 1.
SRT1	-	-83-212°F	SRT1 is a status only item that displays the current suction line refrigerant temperature.

## OAF Set-Up

Table 91: Main Menu \ Advanced Menu \ OAF Circ1 Set-Up

Menu Display Name	Default	Range	Description
<b>FAN STATUS</b>			
OAF1	-	Off On	OAF1 is a status only item that indicates if the OAF1 is on or off
OAF2	-	Off On	OAF2 is a status only item that indicates if the OAF2 is on or off
OA Fans	-	Off On	OA Fans is a status only item that indicates if any OA Fan is on
OAF2 Ovrd	-	Off On	OAF2 Ovrd is a status only item that indicates if OAF2 is being overridden to off.
OA Fan Cmd	-	0-100%	OAF Fan Cmd is a status only item that indicates the commanded OAF Capacity
OA Fan Cap	-	0-100%	OAF Fan Cap is a status only item that indicates the actual OA fan capacity
<b>REFRIG CIRCUIT STATUS</b>			
PTS1	-	0.0-725.29psi	PTS1 is a status only item that displays the current suction line refrigerant pressure for circuit #1
PTD1	-	0.0-725.29psi	PTD1 is a status only item that displays the current discharge line refrigerant pressure for circuit #1
SSH1	-	-115-115°F	SSH1 is a status only item that displays the current suction super heat for circuit #1
DSH1	-	-115-115°F	DSH1 is a status only item that displays the current discharge super heat for circuit # 1
Te1	-	-83.2-212.0°F	Te1 is a status only item that displays the circuit average suction pressure equivalent saturation temperature
Tc1	-	-83.2-212.0°F	TC1 is a status only item that displays the circuit average discharge line pressure equivalent saturation temperature. Calculated from PTD1 using the standard ASHRAE conversion for R32.
C1-3 DRT1-2	-	-83.2-392.0°F	Discharge Refrigerant Temperature for Circuit 1, Compressor 1-2, status only item.
<b>FAN CONTROL</b>			
Eff Tc1	-	-83.2-212°F	Eff Tc1 is a status only item that displays the current Tc set point on circuit 1
OAF Period	1s	0-300s	An adjustable input to set the Outdoor Air Fan speed control Period parameter
OAF Gain	0.1	0.0-10.0	An adjustable input to set the Outdoor Air Fan speed control Gain parameter
OAF PAT	20s	0-300s	An adjustable input to set the Outdoor Air Fan Project Ahead Time parameter
Max OAT Spt	120.0°F		Adjustable value at which the PID controls no longer are used to control head pressure. Fans are overridden to max speed when the ambient temperature exceeds set point.
Max PTD Spt	469.3psi		Adjustable value at which the PID controls no longer are used to control head pressure. Fans are overridden to max speed when the discharge pressure exceeds set point.
TcHPULOffset	5.4°F		A status only item that displays the Saturated Condensing Temperature High Pressure Unloading Offset
TcHPInhbtOfst	6.3°F		A status only item that displays the Saturated Condensing Temperature High Pressure Inhibit Offset

Menu Display Name	Default	Range	Description
TcHPInhbtDiff	2.7°F if YC comp 3.6°F Otherwise	0.0-9.0°F	A status only item that displays the Saturated Condensing Temperature High Pressure Inhibit Differential.
C1 OAF1 Status	-	Fault OK No Comm	A status only item that displays the current Outdoor Air Fan1 Modbus status.
C1 OAF2 Status	-	Fault OK No Comm	A status only item that displays the current Outdoor Air Fan2 Modbus status.

## Economizer and Outside Air Damper

### Building Pressure Override

The minimum position determined by any method described below may be overridden for a variable speed exhaust fan controlled by building static pressure when the exhaust fan has been stopped due to low building static pressure if the building pressure remains negative. If the user elects to use this function and the exhaust fan has been stopped for a minimum exhaust fan off time (default = 120 seconds), a PI\_Loop will begin modulating the Min OA Pos set point upward to maintain the building static pressure at the building static pressure set point.

### Limiting Control

The user has the option of setting a low temperature limit that will override all the outdoor air reset functions described in this section, except if entering fan temperature gets too cold as a result of the reset. The user can choose the override sensor by setting the Reset Temperature Limit to None, DAT, or EFT. When set to None the Reset Temperature Limit function is disabled. A Reset Temperature Limit PI\_Loop will be used to reset the minimum outside air damper set point downward when the selected temperature input drops below the Reset Temperature Limit.

## Econo Set-Up

Table 92: Main Menu \ Advanced Menu \ Econo Set-Up

Menu Display Name	Default	Range	Description
Econo Period	30s	0-999s	Econo Period is an adjustable item which sets the “sampling time” used in the PI control function to vary the Economizer Damper.
Econo Gain	10.0	0.0-100.0	Econo Gain is an adjustable item which sets the “gain” used in the PI control function to vary the Economizer Damper.
Econo PAT	60s	0-999s	Econo PAT is an adjustable item which sets the “project ahead time” used in the PI control function to vary the Economizer Damper.
Econo Max Chg	10%	0-100%	Econo Max Chg is an adjustable item that sets the maximum value for an increase or decrease of the Economizer Damper Position.
EconOutDiff	3%	0-100%	An adjustable item defined as the difference between the outside damper position and the effective minimum outside air position. Used in determining the Economizer Status output.

## OA Damper Set-Up

### OA Damper Set-Up - Ext Reset Control

**Table 93: Main Menu \ Advanced Menu \ OA Damper Set-Up \ Ext Reset Control**

Menu Display Name	Default	Range	Description
Min V/mA	0.0 / V	0.0-20.0 V/mA	Min V/mA is the minimum value of the voltage or mA range for the externally controlled reset input on the controller.
Max V/mA	10.0 / V	0.0-20.0 V/mA	Max V/mA is the maximum value of the voltage or mA range for the externally controlled reset input on the controller.

### OA Damper Set-Up - Flow Reset Control

**Table 94: Main Menu \ Advanced Menu \ OA Damper Set-Up \ Flow Reset Control**

Menu Display Name	Default	Range	Description
Min OAFlow	0 CFM	0-60000CFM	Min OAFlow is the minimum OA flow that corresponds to the V/A@MinOAFlw Voltage or amperage for the Flow Reset.
Max OAFlow	10000CFM	0-60000CFM	Max OAFlow is the maximum OA flow that corresponds to the V/A@MaxOAFlw Voltage or amperage for the Flow Reset.
V/A@MinOAFlw	0.00 /V	0.0-20.0 V/mA	V/A@MinOAFlw is the minimum value of the voltage or mA range for the flow controlled reset input on the controller.
V/A@MaxOAFlw	10.00/V	0.0-20.0 V/mA	V/A@MaxOAFlw is the maximum value of the voltage or mA range for the flow controlled reset input on the controller.
Flow DB	3%	0-100%	Flow DB is an adjustable item that sets the “deadband” used in the PI control function to vary the OA Damper.
Flow Period	30s	0-999s	Flow Period is an adjustable item which sets the “sampling time” used in the PI control function for the OA Flow Damper Reset Control.
Flow Gain	0.1	0.0-100.0	Flow Gain is an adjustable item which sets the “project ahead time” used in the PI control function for the OA Flow Damper Reset Control.
Flow Mx Chg	5%	0-100%	Flow Mx Chg is an adjustable item that sets the maximum value for an increase or decrease of the Flow Reset Control Damper Position.

## OA Damper Set-Up – Fan Diff Control

*Table 95: Main Menu \ Advanced Menu \ OA Damper Set-Up \ Fan Diff Control*

Menu Display Name	Default	Range	Description
Max Fan DiffOA	20%	0-100%	Max Fan DiffOA is an adjustable item which sets the maximum value for an increase or decrease of the outside air damper position due to the Max Fan Diff Control function.

## OA Damper Set-Up – BSP Ovr Control

*Table 96: Main Menu \ Advanced Menu \ OA Damper Set-Up \ BSP Ovr Control*

Menu Display Name	Default	Range	Description
BSPOvrPeriod	5s	0-999s	BSPOvrPeriod is an adjustable item which sets the “sampling time” used in the PI control function used for the building static pressure override feature.
BSPOvrGain	0.2	0-100.0	BSPOvrGain is an adjustable item which sets the “Gain” used in the PI control function used for the building static pressure override feature.
BSPOvrMxChg	4%	0-100%	BSPOvrMxChg is an adjustable item that sets the maximum value for an increase or decrease of the outside air damper position due to the building static pressure override feature.
BSPOvrTime	120s	60-300s	BSPOvrTime is an adjustable item used to set the time period for which the exhaust fan must operate at the minimum speed before the building static pressure override function is activated.

## OA Damper Set-Up – Limiting Control

**Table 97: Main Menu \ Advanced Menu \ OA Damper Set-Up \ Limiting Control**

Menu Display Name	Default	Range	Description
Max OA Pos	100% or 30%	0-100%	Max OA Pos is an adjustable item used to set the maximum outside air damper position.
Min Inc Rate	0.15%/s	0.00-100.00%/s	Min Inc Rate is an adjustable item used to set the minimum increase rate for the outside air damper “cold start” sequence.
Max Inc Rate	1.00%/s	0.00-100.00%/s	Max Inc Rate is an adjustable item used to set the maximum increase rate for the outside air damper “cold start” sequence.
Rst Limit Snsr	None	None DAT EFT ER_LWT	Rst Limit Snsr is an adjustable item used to set the sensor to be used in conjunction with the OA reset limit function.
Rst T Lmt	48.0°F	0-100°F	Rst T Lmt is an adjustable item which sets a temperature low limit which overrides functions that reset the outside air damper position if the temperature gets too cold.
RstT Period	5s	0-999s	RstT Period an adjustable item which sets the “sampling time” used in the PI control function used for the Reset Temperature Limit feature.
RstT Gain	0.2	0-100.0	RstT Gain is an adjustable item which sets the “Gain” used in the PI control function used for the Reset Temperature Limit feature.
RstT PAT	60s	0-999s	RstT PAT is an adjustable item which sets the “project ahead time” used in the PI control function used for the Reset Temperature Limit feature.
RstT MaxChg	4%	0-100%	RstT MaxChg is an adjustable item that sets the maximum change value PI loop used for the Reset Temperature Limit feature.



# Heating

## Gas Furnace Operation - Heating Set-Up

Table 98: Main Menu \ Advanced Menu \ Heating Set-Up

Menu Display Name	Default	Range	Description
Gas Stg Zero	No	No Yes	Adjustable setting which allows for the gas furnace to stage down to zero capacity when the control source temperature is below the heating set point and the discharge air temperature is above the heating DAT set point.
Occ HtgEnable	Yes	No Yes	Occ HtgEnable is an adjustable item which enables and disables the "daytime" heating mode of operation. If the Occ Heating parameter is set to No, the unit will only go into heating during the initial morning warm-up cycle. If the Occ Heating parameter is set to Yes, the unit can go into the heating mode of operation any time during the day.
Htg Warmup Tm	45s	0-45s	Htg Warmup Tm is an adjustable item which is used to set the amount of time the gas burner will remain at a low fire position on 100% OSA units (default 60 seconds) during the special cold start sequence.
Htg HldPeriod	240s	0-999s	Htg HldPeriod is an adjustable item used to set the amount of time that the gas heating valve remains at its calculated value on units equipped with 100% OA (default 240 seconds) during the special cold start sequence. This is to allow the temperature to approach equilibrium with the modulating gas heating valve at a fixed position.
FrzHtgVlvPos	100%	0-100%	FrzHtgVlvPos is an adjustable item that sets the valve position the hot water or steam heating valve will hold during a freeze event. The valve will hold this position for a freeze timer.
Htg Period	60s	0-999s	Htg Period an adjustable item which sets the "sampling time" used in the PI control function that modulates the heating valve or face & bypass dampers.
Htg Gain	0.8	0.0-100.0	Htg Gain is an adjustable item which sets the "Gain" used in the PI control function that modulates the heating valve or face & bypass dampers.
Htg PAT	120s	0-999s	Htg PAT is an adjustable item which sets the "project ahead time" used in the PI control function that modulates the heating valve or face & bypass dampers.
Htg Max Chg	10%	0-100%	Htg Max Chg is an adjustable item that sets the maximum value for an increase or decrease of the heating valve or face& bypass damper position.
ModGasSCREna	No	No Yes	ModGasSCREna is an adjustable item that sets if the unit is equipped to perform a combination SCR electric and natural gas heating sequence.
SCRIdStrtVal	30%	0-100%	An adjustable item to set the SCR Cold Start heating capacity Value.
SCR Min Volts	1.0V	0-10.0V	An adjustable item to set the SCR electric heater minimum voltage.
Curr Htg Stg	0	0-4	Curr Htg Stg is a read only item that displays the current heating stage.
CurrCmpHtgStg	-	0-8	A status only item that displays the Current Compressor Heating Stage.
Prht Period	60s	0-999s	An adjustable input to set the Pre-Heater control Period parameter.
Preheat Gain	0.8	0.0-100.0	An adjustable input to set the Pre-Heater control Gain parameter.
Preheat PAT	120s	0-999s	An adjustable input to set the Pre-Heater control Project Ahead parameter.
Prht Max Chg	10%	0-100%	An adjustable input to set the Pre-Heater Maximum Capacity Change parameter.

## Reheat

### Reheat Compressor Limiting

**Reheat Compressor Limiting** is a function that limits the compressor capacity when a unit with refrigerant reheat, modulating hot gas cannot produce enough capacity to meet the reheat requirements. When this function is active, the controller will act to reduce the capacity of the circuit opposite the reheat circuit by turning Off a fixed capacity compressor in an attempt to increase the leaving coil temperature, and therefore, the discharge air temperature.

### Standard Heat BackUp Reheat

When a unit is equipped with either a modulating gas, hot water, or steam primary heat, this heat may be used as a secondary **Backup Reheat** source. When the unit is equipped with refrigerant reheat and cannot product enough capacity to meet reheat the requirements, the primary heating source can be activated to maintain the discharge air temperature set-point. For this feature to be activated, the BackupRhtEna flag needs to be set to Yes.

## Reheat Set-Up

*Table 99: Main Menu \ Advanced Menu \ Reheat Set-Up*

Menu Display Name	Default	Range	Description
Rht Cmp Lmtg	Yes	No Yes	Rht Cmp Lmtg is an adjustable item that sets if Reheat Compressor Limiting function is allowed or not. When set to Yes, compressor capacity will be reduced to increase the discharge air temperature.
MHG Min Pos	10%	0-100%	MHG Min Pos is an adjustable item used to set the minimum position of the hot gas reheat valve when the PI loop is active.
MHG Max Pos	85%	0-100%	MHG Max Pos is an adjustable item used to set the maximum position of the hot gas reheat valve when the PI loop is active.
Rht Dec Rate	1.00%/s	0-10.0%/s	Rht Dec Rate is an adjustable item used to set the rate of decrease for the reheat valve, where the unit leaves the dehumidification operation.
MHGRht1Status	-	OK VlvConn EMHi EMHdw EMComm	MHGRht1Status is a status only item that shows if status of control on the Modulating Hot Gas Reheat Valve.
BackupRhtEna	No	No Yes	BackupRhtEna is an adjustable item that sets if the unit is allowed to use its primary modulating heater as a secondary reheat source for cases where the primary refrigerant reheat cannot satisfy the discharge air temperature set point.
SCR Suplmt Rht	Yes	No Yes	An adjustable input to enable SCR Electric Heat for reheat.
RhtPeriod	30s	0-999s	RhtPeriod is an adjustable item which sets the "sampling time" used in the PI control function for controlling the reheat valve.
Rht Gain	1.0	0.0-100.0	Rht Gain is an adjustable item which sets the "Gain" used in the PI control function for controlling the reheat valve.
Rht PAT	30s	0-999s	Rht PAT is an adjustable item which sets the "project ahead time" used in the PI control function for controlling the reheat valve.
Rht Max Chg	10%	0-100%	Rht Max Chg an adjustable item that sets the maximum value for an increase or decrease for controlling the reheat valve.
PriHtgRstOAT	65.0°F	50.0-80.0°F	

Menu Display Name	Default	Range	Description
DH Priority	LCT or Rht	Rht LCT	An adjustable item to choose Dehumidification compressor control; either Leaving Coil Temperature or Reheat control.
DH VCmp Min	50%	0-100%	An adjustable item to select the Minimum Variable Compressor Speed when DH Priority is LCT.
Curr Htg Stg	-	0-8	Curr Htg Stg is a status only item that displays the current heating stage of the unit.

## Energy Rec Set-Up

Table 100: Main Menu \ Advanced Menu \ Energy Rec Set-Up

Menu Display Name	Default	Range	Description
Min ExhT Diff	2°F	1.0-20.0°F	Min Exh T Diff is an adjustable item that sets a differential below the calculated potential energy recovery exhaust air frosting point. When the ER Exh T falls below the calculated frosting point by more than this value, the energy wheel will be driven to its minimum speed, or turned OFF, to prevent frosting.
Max ExhT Diff	6°F	1.0-20.0°F	Max Exh T Diff is an adjustable item that sets a differential above the calculated potential energy recovery exhaust air frosting point. Once the wheel is driven to minimum speed, or turned off, to prevent frosting, it is driven back to maximum speed, or turned ON, only when ER Exh T rises back above the calculated frosting point by more than this value.
ERWhl Stg Tm	5min	1-100min	ER Whl Stg Tm is an adjustable item used to set a minimum time period for operating at either the minimum or maximum speed before action is taken to change speed during the frost protect mode of operation.
ER Whel Off Tm	20min	1-100min	ER Whl Off Tm is an adjustable item used to set the minimum amount of time the energy wheel will remain off after being turned OFF due to a frosting/condensation condition.
ERWhl Min Cap	15%	10-100%	ERWhlMinCap is the minimum allowed energy wheel capacity.
EROAEOffset	0.0°F	0.0-10.0°F	
Intersect Pt	-	-146.2-150.0°F	Intersect Pt is the calculated intersection point with saturation line for the process line between the OAT at 95% RH and the actual return air temperature and return air humidity.
RARelHum	-	0-100	RARelHum is a status only item of the current sens air relative humidity reading.
FstMgmt Meth	None	None Timed WhlSpd Preheat	FstMgmtMeth is the selected frost management method.
OA Frst Temp	-5.0 °F	-40-100.0°F	OA Fst Temp is an adjustable item used to set the outside air frost temperature.
Defrost Time	5min	0-60min	Defrost Time is an adjustable item used to set the duration of a defrost cycle.
Defrst Period	60min	0-1440min	Defrst Period is an adjustable item used to set how often a defrost cycle will be initiated.
Defrst On Tm	1s	0-999s	Defrst On Tm is an adjustable item used to select how long the constant speed energy wheel is energized during defrost.
Defrost Off Tm	24s	0-999s	Defrst Off Tm is an adjustable item used to select how long the constant speed energy wheel is de-energized during defrost.

Menu Display Name	Default	Range	Description
Cap Limiting	Yes	No Yes	Capacity Limiting is an adjustable item used to turn ON and OFF the energy wheel capacity limiting function.
ERWhl Period	30.0s	0-999s	ER Whl Period an adjustable item which sets the “sampling time” used in the PI control function.
ERWhl Gain	1.0	0.0-100.0	ER Whl Gain is an adjustable item which sets the “Gain” used in the PI control function.
ER Whl PAT	30.0s	0-999s	ER Whl PAT is an adjustable item which sets the “project ahead time” used in the PI control function.
ERWhl Max Chg	10%	0-100%	ERWhl Max Chg is an adjustable item that sets the maximum value for an increase or decrease of the energy recovery wheel speed.
EWTFrost Spt	32.0°F	23.0-41.0°F	EWTFrost Spt is an adjustable item that sets a minimum entering wheel temp that frost prevention will be allowed at.

## Power Monitor

*Table 101: Main Menu \ Advanced Menu \ Power Monitor*

Menu Display Name	Default	Range	Description
kWhAccumReset	No	No Yes	kWhAccumReset is an adjustable item that allows the user to reset the kWhAccumulated.
AvgkWPeriod	60.0min	0.0-1440.0 min	AvgkWPeriod sets the period used to calculate the average kW.

## A2L Sensors

**Table 102: Main Menu \ Advanced Menu \ A2L Sensors**

Menu Display Name	Default	Range	Description
A2L State=	-	Init Run Fault Alarm Mitig Testing NoComm	A status only item that displays the current A2L Sensor Board Status.
A2L Level Spt=	-	0.0-100.0 %	An adjustable A2L concentration Level Set point where Mitigation will be triggered.
A2L Sensor Cnt=	-	0-8	Status only value displaying the number of A2L leak sensors in the system.

## Sensor Offsets

**Table 103: Main Menu \ Advanced Menu \ Sensor Offsets**

Menu Display Name	Default	Range	Description
Disch Air	0.0	-10.0-10.0°F	Status only value which is the current discharge air temperature.
Return Air	0.0	-10.0-10.0°F	Return Air is an adjustable setting that sets the sensor offset for the sensor.
OA Temp	0.0	-10.0-10.0°F	OA Temp is an adjustable setting that sets the sensor offset for the sensor.
Space Temp 1	0.0	-10.0-10.0°F	Space Temp 1 is an adjustable setting that sets the sensor offset for the sensor.
Space Temp 2	0.0	-10.0-10.0°F	Space Temp 2 is an adjustable setting that sets the sensor offset for the sensor.
Space Temp 3	0.0	-10.0-10.0°F	Space Temp 3 is an adjustable setting that sets the sensor offset for the sensor.
EF/LC Temp	0.0	-10.0-10.0°F	EF/LC Temp is an adjustable setting that sets the sensor offset for the sensor.
ER EWT	0.0	-10.0-10.0°F	ER EWT is an adjustable setting that sets the sensor offset for the sensor.
ER LWT	0.0	-10.0-10.0°F	ER LWT is an adjustable setting that sets the sensor offset for the sensor.
DRT1-2	0.0	-10.0-10.0°F	An adjustable setting for Circuits 1-3/ Compressors 1-6 Discharge Refrigerant Temperatures.
VCmp1 Temp	0.0	-10.0-10.0°F	An adjustable setting for Variable Compressors 1 shell Temperatures.
SRT1	0.0	-10.0-10.0°F	SRT1 is an adjustable setting that sets the sensor offset for the sensor.
DFT1	0.0	-10.0-10.0°F	An adjustable setting for Circuits 1 Defrost Temperatures.
LRT1	0.0	-10.0-10.0°F	LRT1 is an adjustable setting that sets the sensor offset for the sensor.
CompCmdIn=	0.0	-2.0 – 2.0	An adjustable setting for Compressor Capacity Command Input for Refrigerant Only Controls.
HtgCmdIn=	0.0	-2.0 – 2.0	An adjustable setting for Heating Capacity Command Input for Refrigerant Only Controls.

Menu Display Name	Default	Range	Description
C1HiTSnsrCfg=	NTC50K	Unknown NTC10K NTC50K NTC230K	An adjustable setting for Circuit 1 Discharge Refrigerant Temperature sensor type
C1EffHiTSnsrCfg=	-	Unknown NTC10K NTC50K NTC230K	A status only item specifying Circuit 1 Discharge Refrigerant Temperature sensor type

# A2L Detection and Mitigation

## A2L Leak Detection System

Daikin Applied Rooftop units that use an A2L refrigerant have a factory installed leak detection system. The A2L leak detection system consists of the following parts:

- Refrigerant Sensor(s) (quantity 1 – 8)  
Part Number: 910419801
- A2L Leak Detection Control Board (quantity 1)  
Part Number: 910419225

The sensors, if more than one, are wired in a daisy chain configuration and terminated at the mitigation board. The A2L Main Control board communicates the leak detection system status to the MicroTech controller via Modbus. The MicroTech controller will communicate alarms based on this system status in the same way as any other alarm. In addition, 2 alarm relays are provided for the field to connect to directly, as an alternative method to receive the alarm status. See schematic example shown in [Figure 33](#).

**Figure 33: A2L Leak Detector Schematic Sample**

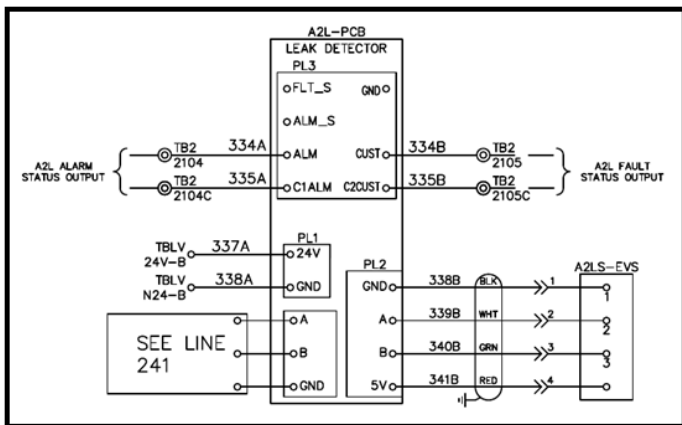

### Alarms

- Refrigerant Leak:
  - The leak detection control board will trigger a leak alarm when at least 1 sensor detects a refrigerant concentration above 15% of the refrigerant Lower Flammability Level (LFL).
  - Upon detection of a leak, the A2L-R1 and A2L-R2 contactors are energized and the alarm is communicated via Modbus to the MicroTech unit controller.
- Refrigerant Sensor Fault:
  - The leak detection control board will trigger a fault alarm when any connected sensor is determined to be faulty (self-test failure, loss of communications, etc.).
  - Upon detection of a sensor fault, the fault is communicated via Modbus to the MicroTech unit controller.

## A2L Leak Mitigation

The MicroTech controller performs the following mitigation sequences to maintain safe operation in the event of an alarm condition:

### Refrigerant Leak Detected

1. When unit is enabled:

Upon notification from the leak detection system that a leak was detected, the MicroTech controller continues to operate the unit normally (conditioning the air: heating, cooling, humidifying, ventilating, and cleaning) with the following exceptions:

- Refrigerant leak alarm is triggered and will remain on until alarm is manually cleared.
- All compressors are deactivated and locked-out.
- Supply fan minimum speed controls are overridden to prevent the fan from operating below a predetermined speed to maintain adequate airflow through the system to dilute any of the leaked refrigerant.
- If the unit state is “OFF”, the unit will start up in the typical unoccupied mode of operation.
- Manual Control operation is disabled.
- The gas or electric heat Cold Start feature is disabled.
- Specific Refrigeration Only Controls (ROC):
  - The field compressor cooling/heating control signal is ignored.
  - Compressors are deactivated and locked-out.
  - Supply fan minimum speed controls are overridden to prevent the fan from operating below a predetermined speed to maintain adequate airflow through the system to dilute any of the leaked refrigerant.
  - The field supplied outside air damper signal on a DOAS unit without a return air opening is ignored and the dampers are overridden to 100%.
  - The field controls are responsible for opening any isolation dampers to allow for airflow through the system.
  - The field controls are responsible for sending cooling and heating capacity signals.

**NOTE:** The mitigation controls continue to monitor the refrigerant sensors in the system and notifies the MicroTech unit controller when no refrigerant has been detected for five minutes, allowing the unit to resume normal operation. However, the Refrigerant Leak Alarm will continue to be active, locking out compressor operation until the alarm is manually cleared.

2. When unit is disabled (see [Table 104 on page 168](#) for typical causes of disabled units):

Upon notification from the leak detection system that a leak was detected, the MicroTech controller performs the following tasks:

- Refrigerant Leak Alarm is triggered and will remain active until manually cleared.

- Compressor operation remains locked-out.
- Supply fan is turned on and supply fan minimum speed controls are overridden to prevent the fan from operating below a predetermined speed to maintain adequate airflow through the system to dilute any of the leaked refrigerant.
- The outside air damper in a DOAS unit without a return air path will be opened to 100%.
- The outside air damper will remain closed with the exception of DOAS units without a return air path.
- Manual Control operation is disabled.
- Fan operation digital output closes.
- VAV box digital output opens (to open boxes).
- Heating and cooling are disabled.

Exceptions (MicroTech will not activate mitigation steps):

- If unit is disabled due to supply fan alarm, the fan will not operate.
- E-Stop circuit is open. E-Stop takes priority over A2L leak alarm.
- High Discharge Air temperature (>170°F) alarms are triggered.

**NOTE:** The mitigation controls will continue to monitor the the refrigerant sensors in the system and notifies the MicroTech unit controller when no refrigerant has been detected for 5 minutes. At that time, the unit will revert back to the previous Disabled state.

**Table 104: Typical Causes for Disabled Units**

Unit Status Enumeration	Description	Conditions
0	Enabled	Conditions for Unit Status Enumerations 1-7 are all false.
1	OffMan	Control Mode is set to Off
2	OffManCtrl	ManCtrActv flag is true.
3	Off Net	Both of the following are true: <ul style="list-style-type: none"> <li>• Control Mode is set to Auto.</li> <li>• NetApplicMode is set to Off.</li> </ul>
4	OffAlm	A fault alarm is active.
5	OffRetry	Fan Retry flag is true.
6	OffPassVnt	PassVentActv flag is true
7	OffSnsrCfg	All of the following are true: <ul style="list-style-type: none"> <li>• CtlrTempSrc is set to Space.</li> <li>• Either of the following is true:                             <ul style="list-style-type: none"> <li>- QMX sensor configuration is in progress.</li> <li>- EffSpcTRel is false.</li> </ul> </li> <li>• Control Temperature fault is inactive.</li> </ul>

### Leak Detection Board Detects a Sensor Fault

A fault can be caused by a leak sensor malfunctioning or being disconnected, an A2L board malfunction or a loss of Modbus communication between the MicroTech unit controller and the A2L board.

#### 1. When unit is enabled:

Upon notification from the leak detection system that a sensor fault is detected, the MicroTech controller continues to operate the unit normally (conditioning the air: heating, cooling, humidifying, ventilating, and cleaning) with the following exceptions:

- Refrigerant Sensor alarm is triggered and will remain on until alarm is manually cleared.
- Supply fan minimum speed controls are overridden to prevent the fan from operating below a predetermined speed to maintain adequate airflow through the system to dilute any of the leaked refrigerant.
- If the unit is “OFF”, it will start up in the typical unoccupied mode of operation.
- The gas or electric heat Cold Start feature is disabled.
- Specific Refrigeration Only Controls (ROC):
  - Supply fan minimum speed controls are overridden to prevent the fan from operating below a predetermined speed to maintain adequate airflow through the system to dilute any of the leaked refrigerant.
  - The field supplied outside air damper signal on a DOAS unit without a return air opening is ignored and the dampers are overridden to 100%.
  - The field controls are responsible for opening any isolation dampers to allow for airflow through the system.
  - The field controls are responsible for sending cooling and heating capacity signals.

**NOTE:** The mitigation controls will continue until the fault is remedied and the alarm is manually cleared.

#### 2. When unit is disabled:

Upon notification from the leak detection system that a sensor fault was detected, the MicroTech controller performs the following tasks:

- Refrigerant Sensor Fault alarm is triggered and will remain on until manually cleared.
- Compressor operation remains locked-out.
- Supply fan is turned on and supply fan minimum speed controls are overridden to prevent the fan from operating below a predetermined speed to maintain adequate airflow through the system to dilute any of the leaked refrigerant.
- The outside air damper in a DOAS unit without a return air path will be opened to 100%.
- The outside air damper will continue to be closed with the exception of DOAS unit without a return air path.
- Fan operation digital output closes.



- VAV box digital output opens (to open boxes).
  - Heating and cooling are disabled.
- Exceptions (MicroTech will not activate mitigation steps):
- If unit is disabled due to supply fan alarm, the fan will not operate.
  - E-Stop circuit is open. E-Stop takes priority over A2L Sensor Fault.
  - High Discharge Air temperature (>170°F) alarms are active.
  - Control Mode is set to Off.
  - Duct High Limit Alarm is active.
  - Freeze-stat alarm is active (DOAS units only).

**NOTE:** The mitigation controls will continue until the fault is remedied and the alarm is manually cleared.

## A2L Leak Detection Sensor and Board Service

- The sensors are not considered “Limited Life Sensors” and therefore, under normal operation, are not expected to be replaced within the life expectancy of the unit.
- The sensors have self-reporting diagnostics, which are monitored by the mitigation board. In the event that the sensor fails, the mitigation board will trigger a “Fault” alarm.
- There are no servicing nor maintenance requirements for the sensor(s) and board.

## A2L Leak Detection Sensor and Board Troubleshooting and Diagnostics

At power up, the Leak Detection Control Board display shows what sensors are detected (SX = 1, sensor X is active and communicating), and what sensors are not detected (SX = 0, sensor X is not communicating or inactive). Where X, is the sensor number (from 1 to 8).

By pressing and holding the push button for:

- *Less than 2 seconds*  
The Leak Detection Control Board display shows the last 10 sensor faults (can be loss of communication or faulted state reported by a specific sensor). General configuration fault (Fit CFG) is also shown when the expected number of sensors does not match the number of sensors detected online.
- *More than 2 seconds and less than 5 seconds*  
The display shows sensor(s) status info:
  - The current LFL level.
  - Loss of communication or faulted state reported by a specific sensor.
- *More than 5 seconds and less than 10 seconds*  
The Leak Detection Control Board starts a mitigation test. The board will go into alarm mode and the MicroTech controller will begin the mitigation sequence. The mitigation test will last approximately 5 minutes.
- *More than 10 seconds*  
The display shows all the GID values supported by the sensor board as shown in Table 105 on page 170.

Table 105: GID Descriptions

GID id	Name	Min Limit	Max Limit	Default	Description
1	Number of Sensors	1	8	2	Number of sensors configured.
2	LFL Fault Threshold	1	10000	500	LFL Threshold for setting a fault.
3	LFL ALARM Threshold	1	1000	150	LFL Threshold setting an alarm. 150 = 15%
4	USB Baud Rate	19200	115200	115200	Baud Rate used for communicating with an external terminal.
5	MODbus Client Baud	19200	38400	38400	Baud Rate used for communicating with the sensors.
6	MODbus Server Baud	9600	115200	19200	Baud Rate used for communicating with an external controller.
7	Test Mitigation Time	10	300	300	Test Mitigation time in seconds.
8	Sensor Warm Up Time	5	180	30	Sensor warm up time during power up in seconds.
9	Mitigation Time	120	1200	300	Mitigation time in seconds after LFL alarm has disappear.
10	Num of Sensors Online	1	8	1	Number of sensors detected online.
11	A2L State	0	5	0	A2L System State. Value = 1, A2L State is "run"
12	Last Fault	0	2	0	Recent Fault, Fault_Codes_e
13	Modbus Server Address	1	10	9	A2L Modbus Address used in Modbus Server Network
14	Sensor Addr Min	45	50	48	Minimum address assigned to a recent discovered sensor.
15	EETbl Save Now	0	1	0	Command to save data on non volatile memory.
16	System Test	0	1	0	System Test Mitigation Request.
17	Display LFL	0	1	0	Display LFL Levels
18	EETbl LoadDefaults	0	1	0	Load Defaults values for those non volatile parameters.
19	EETbl Rev	1	1	1	EE Table Revision
20	Sensor 1 Address	GID14	GID14 + 7	0	Sensor 1 Address
21	Sensor 1 Level	0	65535	0	Sensor 1 LFL reported value. For instance value = 200, then LFL is 20%
22	Sensor 1 State	1	65535	0	Sensor 1 current state. Value = 2, then state is "run"
23	Sensor 1 Faults	0	65535	0	Sensor 1 internal faults reported. For instance value = 0, then no faults.
24	Sensor 1 Temperature	-400	940	0	Sensor 1 Temperature reported value. For instance value = 250, then Temp = 25 C
25	Sensor 1 Humidity	0	1000	0	Sensor 1 Humidity reported value. For instance value = 400, then Humidity = 40%
26	Sensor 1 Pressure	0	4000	0	Sensor 1 Pressure reported value. Not available for now.
27	Sensor 2 Address	GID14	GID14 + 7	0	Sensor 2 Address
28	Sensor 2 Level	0	65535	0	Sensor 2 LFL reported value. For instance value = 200, then LFL is 20%
29	Sensor 2 State	1	65535	0	Sensor 2 current state. Value = 2, then state is "run"

GID id	Name	Min Limit	Max Limit	Default	Description
30	Sensor 2 Faults	0	65535	0	Sensor 2 internal faults reported. For instance value = 0, then no faults.
31	Sensor 2 Temperature	-400	940	0	Sensor 2 Temperature reported value. For instance value = 250, then Temp = 25 C
32	Sensor 2 Humidity	0	1000	0	Sensor 2 Humidity reported value. For instance value = 400, then Humidity = 40%
33	Sensor 2 Pressure	0	4000	0	Sensor 2 Pressure reported value. Not available for now.
34	Sensor 3 Address	GID14	GID14 + 7	0	Sensor 3 Address
35	Sensor 3 Level	0	65535	0	Sensor 3 LFL reported value. For instance value = 200, then LFL is 20%
36	Sensor 3 State	1	65535	0	Sensor 3 current state. Value = 2, then state is "run"
37	Sensor 3 Faults	0	65535	0	Sensor 3 internal faults reported. For instance value = 0, then no faults.
38	Sensor 3 Temperature	-400	940	0	Sensor 3 Temperature reported value. For instance value = 250, then Temp = 25 C
39	Sensor 3 Humidity	0	1000	0	Sensor 3 Humidity reported value. For instance value = 400, then Humidity = 40%
40	Sensor 3 Pressure	0	4000	0	Sensor 3 Pressure reported value. Not available for now.
41	Sensor 4 Address	GID14	GID14 + 7	0	Sensor 4 Address
42	Sensor 4 Level	0	65535	0	Sensor 4 LFL reported value. For instance value = 200, then LFL is 20%
43	Sensor 4 State	1	65535	0	Sensor 4 current state. Value = 2, then state is "run"
44	Sensor 4 Faults	0	65535	0	Sensor 4 internal faults reported. For instance value = 0, then no faults.
45	Sensor 4 Temperature	-400	940	0	Sensor 4 Temperature reported value. For instance value = 250, then Temp = 25 C
46	Sensor 4 Humidity	0	1000	0	Sensor 4 Humidity reported value. For instance value = 400, then Humidity = 40%
47	Sensor 4 Pressure	0	4000	0	Sensor 4 Pressure reported value. Not available for now.
48	Sensor 5 Address	GID14	GID14 + 7	0	Sensor 5 Address
49	Sensor 5 Level	0	65535	0	Sensor 5 LFL reported value. For instance value = 200, then LFL is 20%
50	Sensor 5 State	1	65535	0	Sensor 5 current state. Value = 2, then state is "run"
51	Sensor 5 Faults	0	65535	0	Sensor 5 internal faults reported. For instance value = 0, then no faults.
52	Sensor 5 Temperature	-400	940	0	Sensor 5 Temperature reported value. For instance value = 250, then Temp = 25 C
53	Sensor 5 Humidity	0	1000	0	Sensor 5 Humidity reported value. For instance value = 400, then Humidity = 40%
54	Sensor 5 Pressure	0	4000	0	Sensor 5 Pressure reported value. Not available for now.
55	Sensor 6 Address	GID14	GID14 + 7	0	Sensor 6 Address

GID id	Name	Min Limit	Max Limit	Default	Description
56	Sensor 6 Level	0	65535	0	Sensor 6 LFL reported value. For instance value = 200, then LFL is 20%
57	Sensor 6 State	1	65535	0	Sensor 6 current state. Value = 2, then state is "run"
58	Sensor 6 Faults	0	65535	0	Sensor 6 internal faults reported. For instance value = 0, then no faults.
59	Sensor 6 Temperature	-400	940	0	Sensor 6 Temperature reported value. For instance value = 250, then Temp = 25 C
60	Sensor 6 Humidity	0	1000	0	Sensor 6 Humidity reported value. For instance value = 400, then Humidity = 40%
61	Sensor 6 Pressure	0	4000	0	Sensor 6 Pressure reported value. Not available for now.
62	Sensor 7 Address	GID14	GID14 + 7	0	Sensor 7 Address
63	Sensor 7 Level	0	65535	0	Sensor 7 LFL reported value. For instance value = 200, then LFL is 20%
64	Sensor 7 State	1	65535	0	Sensor 7 current state. Value = 2, then state is "run"
65	Sensor 7 Faults	0	65535	0	Sensor 7 internal faults reported. For instance value = 0, then no faults.
66	Sensor 7 Temperature	-400	940	0	Sensor 7 Temperature reported value. For instance value = 250, then Temp = 25 C
67	Sensor 7 Humidity	0	1000	0	Sensor 7 Humidity reported value. For instance value = 400, then Humidity = 40%
68	Sensor 7 Pressure	0	4000	0	Sensor 7 Pressure reported value. Not available for now.
69	Sensor 8 Address	GID14	GID14 + 7	0	Sensor 8 Address
70	Sensor 8 Level	0	65535	0	Sensor 8 LFL reported value. For instance value = 200, then LFL is 20%
71	Sensor 8 State	1	65535	0	Sensor 8 current state. Value = 2, then state is "run"
72	Sensor 8 Faults	0	65535	0	Sensor 8 internal faults reported. For instance value = 0, then no faults.
73	Sensor 8 Temperature	-400	940	0	Sensor 8 Temperature reported value. For instance value = 250, then Temp = 25 C
74	Sensor 8 Humidity	0	1000	0	Sensor 8 Humidity reported value. For instance value = 400, then Humidity = 40%
75	Sensor 8 Pressure	0	4000	0	Sensor 8 Pressure reported value. Not available for now.
76	DF Saving Time	15	120	15	Data Flash saving time in minutes. How frequent data is saved on non volatile memory.
77	Nominated Sensor Addr	48	55	55	Sensor address to be reset to the default value
78	Sensor Reset Command	0	1	0	Command to invoke sensor function reset, value = 1 then this command is invoked.
79	Sen Func Reset Result	0	1	0	Final result of the sensor reset function operation. Value = 0, the operation was successful.

# Appendix

## Gas Furnace Controller Diagnostic Codes

### Modulating Gas Heat Controller (VB1285) Modbus Addresses

The following **Modbus** points in the modulating gas heat control board will be mapped to the main control board to allow for control and monitoring.

**Table 106: Modulating Gas Heat Controller Addresses**

Modbus Addresses					
Functions	Modbus Ref	Functn Code	Modbus Value	Ctrl Values	
Firing Rate	40006	16	16#FF00: Off 16#FE01 to 16#37C8: Minimum Fire- Maximum Fire (note: msb must be the one's complement of the lsb)	ModGasCmd: 0-100	
Burner State	40003	03	Bit	Value	ModCtrlState
			7	0/1	Flame Detected
			5	0/1	Pressure Switch Closed
			0-3	8-15	Reserved (0)
				7	Run (1)
				6	Warm-Up (2)
				5	Gas On (3)
				4	Igniter On (4)
				3	Pre-Purge (5)
				2	Off (6)
1	Retry (Interpurge) (7)				
0	Lockout (8)				

Modbus Addresses							
Functions	Modbus Ref	Functn Code	Modbus Value	Ctrl Values			
Burner Status (Diagnostic/ Error Codes)	40005	03	Bit	Code Value	Text Display MSV	Burner Module LED Display MSV	Description
	Lockout Error Code		8-15	0	None (0)	000 (0)	No Codes
3				UnExpMFIm1 (1)	E08 (1)	Unexpected flame, main burner	
4				UnExpMFIm2 (2)	E08 (2)	Unexpected flame, main burner	
6				OpnFuse (3)	E13 (3)	Open fuse	
7				PriLmt (4)	E02 (4)	Primary limit failure (or open fuse)	
8				ModVFail (5)	E03 (5)	Modulation valve failure	
9				SafeStrt13 (6)	E03 (6)	Safe start failure (Diagnostic Code 13 prior to light off)	
				SafeStrt14 (7)	E04 (7)	Safe start failure (Diagnostic Code 14 prior to light off)	
				SafeStrt15 (8)	E05 (8)	Safe start failure (Diagnostic Code 15 prior to light off)	
10				IDErr (9)	EiD (9)	Invalid ID plug installed	
18				UnExpSFIm (10)	E18 (10)	Unexpected flame, split manifold	
22				IgFailM (11)	E01 (11)	Failed ignition after retries	
26				RWEnaFail (12)	E09 (12)	No R/W enable signal during call for heat	
28				AirPLow (13)	E04 (13)	Air pressure sensor reading low (pressure switch failed to open or insufficient air/blocked vent)	
29				AirPHi (14)	E05 (14)	Air pressure sensor reading high (pressure switch failed to close)	
Other	Other (15)	*** (15)	Board failure				
Diagnostic Code		0-7	0	None (0)	000 (0)	No codes	
			1	BrdFail (1)	*** (1)	Board failure	
			2	Off (2)	OFF (2)		
			3	Start (3)	*** (3)	Startup sequence active	
			4	IgnFail (4)	A01 (4)	Failed ignition attempt	
			5	FImLoss (5)	A02 (5)	Lost flame	

Modbus Addresses											
Functions	Modbus Ref	Functn Code	Modbus Value	Ctrl Values							
Burner Status (Diagnostic/ Error Codes)	Diagnostic Code		0-7	6	CombAir (6)	A03 (6)	Insufficient combustion air				
				7	LoFLmtd (7)	A04 (7)	Limited low fire				
				8	WkFlmM (8)	A05 (8)	Weak flame signal main burner				
				9	NA (9)	A06 (9)	NA				
				10	WkFlmS (10)	A15 (10)	Weak flame signal split burners(s)				
				11	IgnFailM (11)	E01 (11)	Failed ignition after retries, main burner				
				12	LmtFail (12)	E02 (12)	Primary limit failure (or open fuse)				
				13	ModVlv (13)	E03 (13)	Modulation valve failure				
				14	AirPLow (14)	E04 (14)	Air pressure sensor reading low (pressure switch failed to open or insufficient air/blocked vent)				
				15	AirPHi (15)	E05 (15)	Air pressure sensor reading high (pressure switch failed to close)				
				16	NA (16)	NA (16)	NA				
				17	NA (17)	NA (17)	NA				
				18	UexpFIM (18)	E08 (18)	Unexpected flame, main burner				
				19	NoR/W (19)	E09 (19)	No R/W enable signal during call for heat				
				20	IDErr (20)	EiD (20)	Invalid ID plug installed				
				21	NA (21)	NA (21)	NA				
				22	UexpFIS (18)	E18 (22)	Unexpected flame, split manifold				
				23	OpnFuse (19)	E13 (23)	Open fuse				
				24	IgFailS (20)	A11 (24)	Failed ignition after retries, split burner(s)				
				33	AirFail (21)	A07 (33)	Air modulation failure (inducer fan not ramping down)				
				34	AirPSns (22)	A08 (34)	Air pressure sensor null pressure check (out of tolerance)				
				Reset Pending Counter	30021	04	0-65535	Value greater than 600 indicates reset not pending Value 0-600 indicates time in seconds until reset			

# ModBus

## Modbus I/O

A large number of devices in the unit are controlled via a RS-485 bus built into the unit controller using **Modbus** protocol. These devices are.

- One or more ECM Supply Fans
- One or more ECM Exhaust Fans
- Energy Recovery Wheel ECM
- Gas heat Controller
- Variable Capacity Compressor Control Boards

**Figure 34: Modbus Network Configuration**

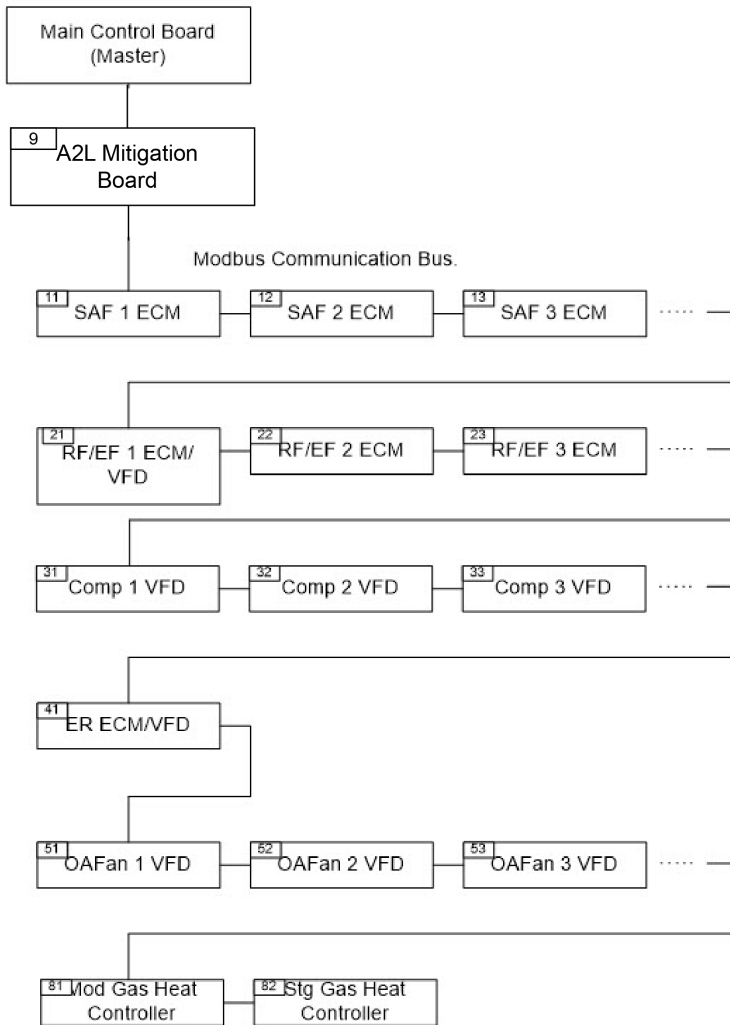

## Data Snapshot Tables

The following tables show the data snapshots that are taken at the time of an alarm or event.

MCB = Main Control Board

EM = Expansion Module.

+ = Denotes the 96UE version of the Expansion Module



Table 107: Data Set 1-5

Data Set 1	Data Set 2	Data Set 3	Data Set 4	Data Set 5
'Unit\UnitState'	'Unit\InviEconEnaS'	'Unit\PassVentActv"	'Unit\Circuit1.EVState'	'Unit\C1EffDRT1'
'Unit\HtgStatus'	'Unit\ERCapFbk'	'Unit\HiPress1'	'Unit\Cir1EVI1Pos'	'Unit\C1EffDRT3'
'Unit\DehumStatus'	'Unit\ExtOAInput'	'Unit\HiPress2'	'Unit\Cir1EVI2Pos'	'Unit\C1EffDRT5'
'Unit\ReheatCapacity'	'Unit\DiagCodeStgG2'	'Unit\ER LWT'	'Unit\Cir1EVOPos'	'Unit\Tp1'
'Unit\OADmprOut'	'Unit\DiagCodeStgG3'	'Unit\MinSAFCap'	'Unit\Cir2EVOPos'	'Unit\Tp2'
'Unit\CtrlTempSrc'	'Unit\DiagCodeModG'	'Unit\MaxSAFCap'	'Unit\Cir3EVOPos'	'Unit\Tp3'
'Unit\ControlTemp'	'Unit\ErrCodeModG'	'Unit\ECM_SAF1Status'	'Unit\PTS1Avg'	'Unit\SRT1'
'Unit\EffOAT'	'Unit\ReheatSpt'	'Unit\VFDAnlg_ SAFStatus"	'Unit\PTD1Avg'	
'Unit\EFT_LCT'	'Unit\InviPrmClgEnS'	'Unit\VFD2Anlg_ SAFStatus"	'Unit\PTD2Avg'	'Unit\SSH3'
'Unit\SpaceRelHum1'	'Unit\InviPrmClgEnV'	'Unit\VFD3Anlg_ SAFStatus"	'Unit\PTD3Avg'	
'Unit\SpaceRelHum2'	'Unit\InviPrmHtgEnS'	'Unit\VFD_SAFStatus"	'Unit\Tc1'	'Unit\DSH1'
'Unit\SAFCapOut'	'Unit\InviPrmHtgEnV'	'Unit\ECM_EF1Status"	'Unit\Tc2'	'Unit\DSH2'
'Unit\SAFCapFbk'	'Unit\RARelHum'	'Unit\ECM_EF2Status"	'Unit\Tc3'	'Unit\DSH2'
'Unit\OAFflow'	'Unit\OARelHum'	'Unit\ECM_EF3Status"	VFDAnlg_EFStatus	'Unit\VCmp1Temp'
		'Unit\ECM_EF4Status"	VFD_EFStatus	
		'Unit\ECM_EF4Status"		
		'Unit\ECM_EF6Status"		
		'Unit\VFDAnlg_ EFStatus"		
		'Unit\VFD2Anlg_ EFStatus"		
		'Unit\VFD3Anlg_ EFStatus"		
		'Unit\VFD_EFStatus"		

**Table 108: Data Set 6-10**

<b>Data Set 6</b>	<b>Data Set 7</b>
'Unit\C1CmpOnOff	'Unit\Circuit1.HMIState'
'Unit\VCmp1RPSOut'	'Unit\IFB1CommStatus'
'Unit\Circuit1.EffSSHSpT'	'Unit\C1IFInptStat'
'Unit\VCmpMB1.VCmpAlarmDec'	'Unit\C1OAF1Status'
'Unit\VCmpMB2.VCmpAlarmDec'	'Unit\VCmp1FinTemp'
'Unit\VCmpMB1.OF1AlarmDec'	'Unit\VCmp1HtSinkTmp'
'Unit\VCmpMB1.OF2AlarmDec'	'Unit\VCmp1CtrlCrdT'
'Unit\C1EVI1Status'	'Unit\VCmp1PriAmps'
'Unit\C1EVI2Status'	'Unit\VCmp1SecAmps'
'Unit\C1EVOSStatus'	
'Unit\EHGBP1CapOut'	
'Unit\EHGBP2CapOut'	
'Unit\RhtBldVlvOut'	

# Limited Warranty



**DAIKIN APPLIED AMERICAS INC.  
LIMITED PRODUCT WARRANTY  
(United States and Canada)**

## **WARRANTY**

Daikin Applied Americas Inc. dba Daikin Applied ("Company") warrants to contractor, purchaser and any owner of the product (collectively "Owner") that, subject to the exclusions set forth below Company, at its option, will repair or replace defective parts in the event any product manufactured by Company, including products sold under the brand name Daikin and used in the United States or Canada, proves defective in material or workmanship within twelve (12) months from initial startup or eighteen (18) months from the date shipped by Company, whichever occurs first. Authorized replacement parts are warranted for the remainder of the original warranty. All shipments of such parts will be made FOB factory, freight prepaid and allowed. Company reserves the right to select carrier and method of shipment. In addition, Company provides labor to repair or replace warranty parts during Company normal working hours on products with rotary screw compressors or centrifugal compressors. Warranty labor is not provided for any other products.

Company must receive the Registration and Startup Forms for products containing motor compressors and/or furnaces within ten (10) days of original product startup, or the ship date and the startup date will be deemed the same for determining the commencement of the warranty period and this warranty shall expire twelve (12) months from that date. For additional consideration, Company will provide an extended warranty(ies) on certain products or components thereof. The terms of the extended warranty(ies) are shown on a separate extended warranty statement.

No person (including any agent, sales representative, dealer or distributor) has the authority to expand the Company's obligation beyond the terms of this express warranty or to state that the performance of the product is other than that published by Company.

## **EXCLUSIONS**

1. If free warranty labor is available as set forth above, such free labor does not include diagnostic visits, inspections, travel time and related expenses, or unusual access time or costs required by product location.
2. Refrigerants, fluids, oils and expendable items such as filters are not covered by this warranty.
3. This warranty shall not apply to products or parts : (a) that have been opened, disassembled, repaired, or altered, in each case by anyone other than Company or its authorized service representative; (b) that have been subjected to misuse, abuse, negligence, accidents, damage, or abnormal use or service; (c) that have not been properly maintained; (d) that have been operated or installed, or have had startup performed, in each case in a manner contrary to Company's printed instructions; (e) that have been exposed, directly or indirectly, to a corrosive atmosphere or material such as, but not limited to, chlorine, fluorine, fertilizers, waste water, urine, rust, salt, sulfur, ozone, or other chemicals, contaminants, minerals, or corrosive agents; (f) that were manufactured or furnished by others and/or are not an integral part of a product manufactured by Company; or (g) for which Company has not been paid in full.
4. This warranty shall not apply to products with rotary screw compressors or centrifugal compressors if such products have not been started, or if such startup has not been performed, by a Daikin Applied or Company authorized service representative.

## **SOLE REMEDY AND LIMITATION OF LIABILITY**

THIS WARRANTY CONSTITUTES THE SOLE WARRANTY MADE BY COMPANY. COMPANY'S LIABILITY TO OWNER AND OWNER'S SOLE REMEDY UNDER THIS WARRANTY SHALL NOT EXCEED THE LESSER OF: (i) THE COST OF REPAIRING OR REPLACING DEFECTIVE PRODUCTS; AND (ii) THE ORIGINAL PURCHASE PRICE ACTUALLY PAID FOR THE PRODUCTS. COMPANY MAKES NO REPRESENTATION OR WARRANTY, EXPRESS OR IMPLIED, REGARDING PREVENTION OF MOLD/MOULD, FUNGUS, BACTERIA, MICROBIAL GROWTH, OR ANY OTHER CONTAMINATES. THIS WARRANTY IS GIVEN IN LIEU OF ALL OTHER WARRANTIES, INCLUDING, WITHOUT LIMITATION, THE IMPLIED WARRANTIES OF MERCHANTABILITY, FITNESS FOR A PARTICULAR PURPOSE, AND NON-INFRINGEMENT, WHICH ARE HEREBY DISCLAIMED. IN NO EVENT AND UNDER NO CIRCUMSTANCE SHALL COMPANY BE LIABLE TO OWNER OR ANY THIRD PARTY FOR INCIDENTAL, INDIRECT, SPECIAL, CONTINGENT, CONSEQUENTIAL, DELAY OR LIQUIDATED DAMAGES FOR ANY REASON, ARISING FROM ANY CAUSE WHATSOEVER, WHETHER THE THEORY FOR RECOVERY IS BASED IN LAW OR IN EQUITY, OR IS UNDER A THEORY OF BREACH CONTRACT OR WARRANTY, NEGLIGENCE, STRICT LIABILITY, OR OTHERWISE. THE TERM "CONSEQUENTIAL DAMAGE" INCLUDES, WITHOUT LIMITATION, THOSE DAMAGES ARISING FROM BUSINESS INTERRUPTION OR ECONOMIC LOSS, SUCH AS LOSS OF ANTICIPATED PROFITS, REVENUE, PRODUCTION, USE, REPUTATION, DATA OR CROPS.

## **ASSISTANCE**

To obtain assistance or information regarding this warranty, please contact your local sales representative or a Daikin Applied office.

Form No. 933-430285Y-01-A (11/2023)  
Part No. 043028500 Rev.0F

# COMPLETE HVAC SYSTEM SOLUTIONS

SELF-CONTAINED | ROOFTOPS | COILS | CONDENSING UNITS  
AIR HANDLERS | WATER-COOLED CHILLERS | AIR-COOLED CHILLERS  
MODULAR CENTRAL PLANTS | SITELINE BUILDING CONTROLS  
UNIT HEATERS | FAN COILS | AIR PURIFIERS | WATER SOURCE HEAT PUMPS  
VARIABLE AIR VOLUME UNITS | UNIT VENTILATORS



13600 INDUSTRIAL PARK BLVD. | MINNEAPOLIS, MN 55441  
1-800-432-1342 | 763-553-5330

LEARN MORE AT  
**DAIKINAPPLIED.COM**

PART NUMBER: OM 1382

© 2024 DAIKIN APPLIED | (800) 432.1342 | WWW.DAIKINAPPLIED.COM